



**NEW!**

## OVERVIEW

**USE CTRL+F FUNCTION TO FAST SEARCH**

Buckeye Pads and Covers has been manufacturing tailor made laundry press pads and covers for over 50 years. We use blueprints, supplied by the original equipment manufacturers (OEM's), to assure a proper fit and the highest quality finish. All Buckeye laundry covers are constructed with a three-dimensional skirted design, to provide a custom fit for each machine. We also offer different material and flannel combinations to satisfy every possible pressing need.



### **Bon-Pak Cover/Pad Combo**

The Bon-Pak Cover/Pad Combo is the ultimate for pressing on flatbed presses. The Bon-Pak consists of a Bon-Twill double warp nylon cover, and a 50 ounce Bonn-E-Blue nylon flannel sewn together for a quick and easy installation. This pad and cover combo will provide an outstanding performance as well as an extended life span.

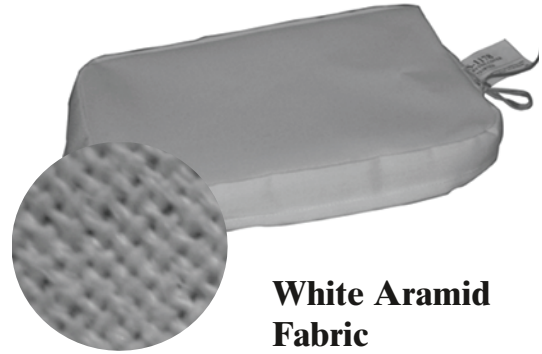

### **White Aramid Fabric**

White Aramid cover cloth is a versatile fabric with many dry cleaning and laundry applications. The material has the needed flexibility to produce a superior finish. It has the breathability for timely drying, and the durability that provides extended cover life. This material is a requirement for many of the Asian pressing machines now available.

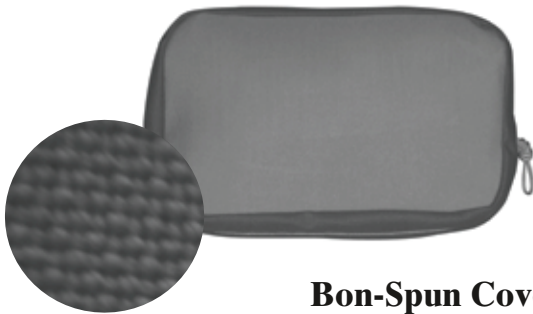

### **Bon-Spun Cover**

The Bon-Spun Cover cloth is spun nylon. This essential cover material is used for laundry flatbed presses and some body bosom applications. Bon-Spun has a high thread count that allows for a tight weave, which will not transfer to the finished garments. The closeness of the weave makes the material more durable and gives Bon-Spun a smooth finish. Because of the spun construction, the fabric also provides the non-slip surface required on body bosom, collar and cuff, and flatbed presses.

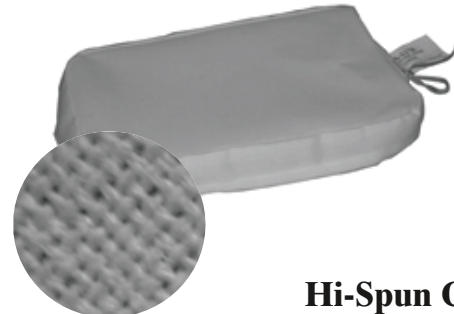

### **Hi-Spun Cover**

Buckeye's Hi-Spun Cover is made from our most durable cover material. This high quality aramid fabric will withstand high heat temperatures, and is a must on electric presses. The combination of heat resistance and high tensile strength makes for a cover material that provides long lasting performance. Used primarily on the laundry side, Hi-Spun has several dry cleaning applications such as ironing boards, etc.



## OVERVIEW, CONTINUED

---

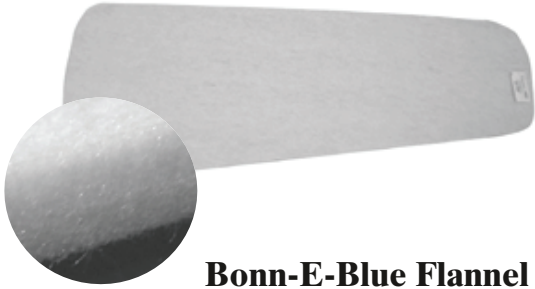

### **Bonn-E-Blue Flannel**

Bonn-E-Blue Flannel is a double-faced, needle-punched, nylon flannel padding. Made from virgin nylon fibers, Bonn-E-Blue has a high density that makes it withstand compression and provides long lasting performance. It is recommended for many cabinet body bosom presses as well as being ideal for use on collars and cuffs and all flatbed presses. Bonn-E-Blue is available in 50-, 30-, and 20-ounce weights.



## CONTENTS

AJAX/ALLIANCE/AMERICAN/ACECO/MARTIN	
EQUIPMENT PICTURES	1
EMPRESS CABINET BOSOM PRESSES	3
18" CABINET BOSOM PRESSES	3
20" CABINET BOSOM PRESSES	4
CABINET BOSOM PRESSES	4-5
CABINET SLEEVE PRESSES	6-7
FLATBED PRESSES	8-19
APEX	19
BARBANTI	19
CISSELL	
CABINET BOSOM PRESSES	20
SLEEVE PRESSES	20
HOT AIR SHIRT FINISHERS	21
FLATBED PRESSES	21
COLMAC	
EQUIPMENT PICTURES	22
SHIRT PRESSES AND COLLAR & CUFF UNITS	23
CABINET AIR BAG BODY PRESSES	24
CABINET AIR BAG SLEEVERS	24
PANT-A-MATIC	25
FIMAS	26
FORENTA/FORSE	
EQUIPMENT PICTURES	27
CABINET BOSOM PRESSES WITH EXPANDERS	28
CABINET BOSOM PRESSES	29
CABINET SLEEVE PRESSES	29-30
CABINET AIR BAG BODY PRESSES	30
SLEEVERS — POST, FLEX WING, AND CABINET	31
FLATBED PRESSES	32-36
FUJICAR	37
FUJICAR / FUJISTAR / Y.A.C.	
EQUIPMENT PICTURES	38
AIR BAG BODY PRESSES	39
SLEEVER UNITS	39
FLATBED PRESSES	39
GOBUKSON	40
GOLDMAN	40

CONTINUED ON NEXT PAGE



## CONTENTS

HI STEAM	40
<hr/>	
HOFFMAN/NEW YORKER/RHEEM	
EQUIPMENT PICTURES	41
CABINET BOSOM PRESSES	42
CABINET SLEEVE PRESSES	42
FLATBED PRESSES	43-44
HOT AIR SHIRT FINISHERS	45
<hr/>	
ITSUMI	45
<hr/>	
KUMSUNG	46
<hr/>	
MACPI/MIRACLEAN	46
<hr/>	
MCALLISTER	46
<hr/>	
MITSUBISHI	47
<hr/>	
OTHIS	47
<hr/>	
PANTEX	48-49
<hr/>	
PONY	50
<hr/>	
PROSPERITY	
CABINET BOSOM PRESSES WITH EXPANDERS	50
CABINET SLEEVERS WITH EXPANDERS	51
FLATBED PRESSES	52-55
<hr/>	
ROTONDI	56
<hr/>	
SAILSTAR	56
<hr/>	
SANKOSHA	
EQUIPMENT PICTURES	57-58
SHIRT PRESSES	59-61
FLATBED PRESSES	62-63
<hr/>	
SILVERSTAR	63
<hr/>	
TREVIL	63
<hr/>	
TROY	64
<hr/>	
UNIPRESS	
EQUIPMENT PICTURES	65
CABINET AIR BAG BODY PRESSES	66-77
CABINET AIR BAG SLEEVERS	77
CABINET BODY PRESSES WITH EXPANDERS	78
CABINET SLEEVERS WITH EXPANDERS	79
MINIMATIC SLEEVERS	79
FLATBED PRESSES	80-88
<hr/>	
VEIT	88
<hr/>	
WESTERN AUTOMATION VIBRA STEAMER	89



**AJAX/ALLIANCE/AMERICAN/ACECO/MARTIN  
EQUIPMENT**



1854



2442



3612



451



AJAX ROTATING  
DOUBLE BUCK  
(ASDBY-MV)



554

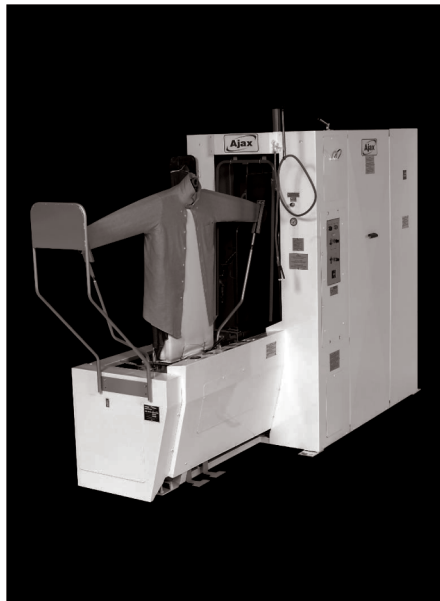

ASBBY-MV



CBS-X



“SPRING LOADED” yoke air bag prevents flattening of the bag during dressing of the unit. This design allows maximum yoke bag expansion throughout the additional drying time so vital for a better yoke finish.

Texsteel steel base pads provide resiliency and dissipate moisture producing a smooth crisp finish, eliminating button breakage.



# LAUNDRY



## AJAX/ALLIANCE/AMERICAN/ACECO/MARTIN EMPRESS CABINET BOSOM PRESSES

MFG. MODEL NUMBER	DESCRIPTION	COVERS		FLANNEL PADS				TEXSTEEL STEEL BASE PAD
		*SPRING LOADED YOKE WHITE SIDES	WHITE SIDES	50 OZ. PRYME	30 OZ. PRYME	50 OZ. BONN-E-BLUE	30 OZ. BONN-E-BLUE	
ASBBY-MV	SINGLE	N/A	AW-1731	H-1730	F-1730	HB-1730	FB-1730	TS-1730
ASDBY-MV	ROTATING DOUBLE	AW-1952	AW-1946	H-1946	F-1946	HB-1946	FB-1946	TS-1946

\* Spring loaded yoke can be seen on Page LA 2.

## AJAX/ALLIANCE/AMERICAN/ACECO/MARTIN 18" SINGLE & DOUBLE CABINET BOSOM PRESSES

MFG. MODEL NUMBER	DESCRIPTION	COVERS				FLANNEL PADS				TEXSTEEL STEEL BASE PAD
		SPRING LOADED YOKE WHITE SIDES	WHITE SIDES	SPRING LOADED YOKE LARGE WHITE SIDES	LARGE WHITE SIDES	50 OZ. PRYME	30 OZ. PRYME	50 OZ. BONN-E-BLUE	30 OZ. BONN-E-BLUE	
CBBY CBBY-S CBBY-X DFB DFB-S DFB-X	SINGLE ↓ DOUBLE ↓	AW-521	AW-324	AW-1474	AW-1420	H-324	F-324	HB-324	FB-324	TS-324
ALC-145LLV CBBY-CV CBBY-FV CBBY-V CBBY-XV ALC-265LLV DFB-CV DFB-FV DFB-SV DFB-V DFB-XV	SINGLE VACUUM ↓ DOUBLE VACUUM ↓									

### ITEMS FOR ABOVE PRESSES

DESCRIPTION	ITEM NUMBER
Top Gasket Cover/Pad	M-1706
Bottom Gasket Cover/Pad	M-1679
HI-SPUN Clamp Covers	HS-1326
Side Bag Springs	M-113



## AJAX/ALLIANCE/AMERICAN/ACECO/MARTIN 20" SINGLE & DOUBLE CABINET BOSOM PRESSES

MFG. MODEL NUMBER	DESCRIPTION	COVERS				FLANNEL PADS				TEXSTEEL STEEL BASE PAD
		SPRING LOADED YOKE WHITE SIDES	WHITE SIDES	SPRING LOADED YOKE LARGE WHITE SIDES	LARGE WHITE SIDES	50 OZ. PRYME	30 OZ. PRYME	50 OZ. BONN-E-BLUE	30 OZ. BONN-E-BLUE	
<b>CBBY</b> <b>CBBY-X</b> <b>DFB</b> <b>DFB-X</b>	SINGLE ↓ DOUBLE	AW-533	AW-352	AW-1945	AW-1947	H-352	F-352	HB-352	FB-352	TS-352
<b>ALC-145LLV</b> <b>CBBY-CV</b> <b>CBBY-FV</b> <b>CBBY-XV</b> <b>ALC-265LLV</b> <b>DFB-CV</b> <b>DFB-FV</b> <b>DFB-XV</b>	SINGLE VACUUM ↓ DOUBLE VACUUM	AW-533	AW-352	AW-1945	AW-1947	H-1683	F-1683	HB-1683	FB-1683	TS-1683

## AJAX/ALLIANCE/AMERICAN/ACECO/MARTIN CABINET BOSOM PRESSES

MFG. MODEL NUMBER	BUCK DESCRIPTION	COVER	FLANNEL PADS			TEXSTEEL STEEL BASE PAD
		SPRING LOADED YOKE WHITE SIDES	50 OZ. PRYME	30 OZ. PRYME	50 OZ. BONN-E-BLUE	
<b>CBBY-A1</b> (PC364) <b>CBBY-SA1</b> (PC764) <b>DFB-A1</b> (PC360) <b>DFB-SA1</b> (PC760)	SINGLE MILITARY ↓ DOUBLE MILITARY	AW-530	H-345	F-345	HB-345	TS-345

### ITEMS FOR ABOVE PRESSES

DESCRIPTION	ITEM NUMBER
Top Gasket Cover/Pad	M-1706
Bottom Gasket Cover/Pad	M-1679
HI-SPUN Clamp Covers	HS-1326
Side Bag Springs	M-113

# LAUNDRY



## AJAX/ALLIANCE/AMERICAN/ACECO/MARTIN CABINET BOSOM PRESSES

MFG. MODEL NUMBER	DESCRIPTION	COVERS		FLANNEL PADS			TEXSTEEL STEEL BASE PAD
		SPRING LOADED YOKE WHITE SIDES	WHITE SIDES	50 OZ. PRYME	30 OZ. PRYME	50 OZ. BONN-E- BLUE	
<b>CBBY-IVY</b> (PC364) <b>CBBY-SIVY</b> (PC764) <b>DFB-IVY</b> (PC360) <b>DFB-SIVY</b> (PC760)	SINGLE ↓ DOUBLE ↓	AW-509	AW-288	H-288	F-288	HB-288	TS-288
<b>CSLC 18"</b> (PC362) <b>DFB-LC 18"</b> (PC362)	SINGLE LAB COAT DOUBLE LAB COAT						

## CABINET BOSOM PRESSES - TRIPLE BUCKS

MFG. MODEL NUMBER	DESCRIPTION	COVER	FLANNEL PADS				TEXSTEEL STEEL BASE PAD
		WHITE SIDES W/ YOKE BAG	50 OZ. PRYME	30 OZ. PRYME	50 OZ. BONN-E- BLUE	30 OZ. BONN-E- BLUE	
<b>ROTO PRO</b> (PC355)	TRIPLE	AW-1623	H-1623	F-1623	HB-1623	FB-1623	CALL BUCKEYE

MFG. MODEL NUMBER	DESCRIPTION	COVER AND PAD COMBINATION		TEXSTEEL STEEL BASE PAD
		WHITE SIDES W/ 30 OZ. PAD	WHITE SIDES W/ 50 OZ. PAD	
<b>TRIPLE PRO</b> (PC356)	TRIPLE	AWF-1625	AWH-1625	CALL BUCKEYE



## AJAX/ALLIANCE/AMERICAN/ACECO/MARTIN CABINET SLEEVE PASSES

MFG. MODEL NUMBER	DESCRIPTION	COVERS		PADS			
		PFW/ OVERSIZED WHITE SIDES	PFW/ WHITE SIDES	20 OZ STOCKING BONN-E-BLUE PAD	TEXSTEEL STEEL BASE PAD (SET OF 2)	SPRING PAD ASSEMBLY (SET OF 4)	CLEAN BOOT
ACBSC CBS (PC363)	Shirt	PFW-1789*	PFW-154*	DB-153*	Set TS-154	Set SPA-154	M-801*
CBS-B	Boys	N/A	PFW-48*	DB-47*	Set TS-48	N/A	M-801*
CBS-C (PC365)	Coat	N/A	PFW-159*	DB-158*	Set TS-159	N/A	M-801*
CBS-L CBS-X (PC366)	Shirt	N/A	PFW-1669*	DB-153*	Set TS-154	Set SPA-154	M-801*

\* Requires 2

- The 20 oz. slip-over stocking BONN-E-BLUE pad (**DB-153, DB-47, & DB-158**) is designed for use over worn steel base pads.
- TEXSTEEL steel base pads (**Set TS-154, Set TS-48, & Set TS-159**) are enclosed with heat resistant zip-on material for easy installation.

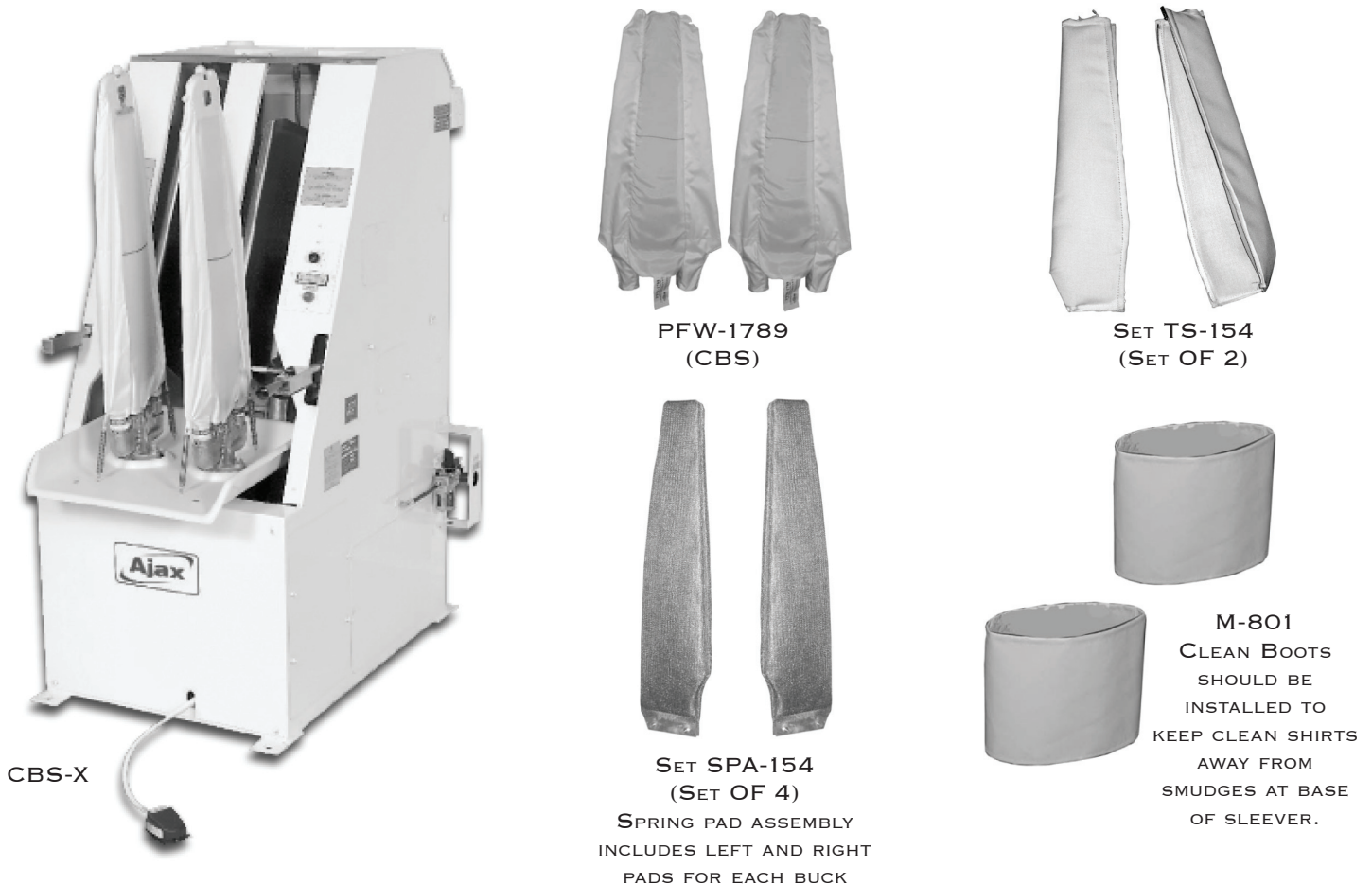



## AJAX/ALLIANCE/AMERICAN/ACECO/MARTIN CABINET SLEEVE PASSES

MFG. MODEL NUMBER	DESCRIPTION	EXPANDERS			COVER AND PAD		
		POLYESTER COVER W/ 30 OZ. PRYME PAD	UNI-DAC COVER	20 OZ. PAD	TEXSTEEL STEEL BASE PAD (SET OF 2)	FIL-NYL AIR BAG	HI-SPUN W/DFN (GUSSET)
CS	Cabinet	CPFB-135*	M-132* W/HINGE M-131* WO HINGE	DB-132* DB-131*	Set TS-135	N/A	N/A
K-SAM MM-SL (PC329)	Air Bag	N/A	N/A	N/A	N/A	M-696*	HTD-6*
620	Cabinet	CPFB-75*	M-65* (Current Style) M-63* (Old Style)	DB-65* (Current Style) DB-63* (Old Style)	Set TS-75	N/A	N/A

\* Requires 2



MM-SL  
K-SAM

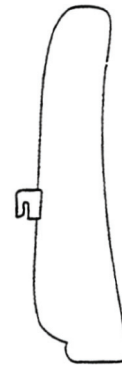

#132  
WITH HINGE

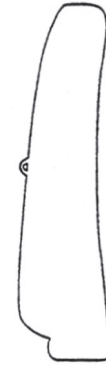

#131  
WITHOUT HINGE



#65  
CURRENT STYLE



#63  
OLD STYLE



## AJAX/ALLIANCE/AMERICAN/ACECO/MARTIN FLATBED PRESSES

MFG. MODEL NUMBER	BUCK SIZE	DESCRIPTION	COMBO	COVERS		PADS	TEXSTEEL STEEL BASE PAD*
			BONPAK NYLON COVER/ PAD	BON-SPUN NYLON	HI-SPUN ARAMID	50 OZ. BONN-E- BLUE	
<b>BB-C</b> (PC330)	30 1/2 x 14	Body Bosom	<b>BP-166</b>	<b>B-166</b>	<b>HS-166</b>	<b>HB-166</b>	<b>TS-1</b>
<b>BCC</b>	17 x 7 11 x 7	Boys Collar Cuffs (2)	<b>BP-38</b> <b>BP-715</b>	<b>B-38</b> <b>B-715</b>	<b>HS-38</b> <b>HS-715</b>	<b>HB-38</b> <b>HB-715</b>	<b>TS-2</b> (Set of 3)
<b>B-SBB</b>	30 x 12	Boys Body Bosom	<b>BP-164</b>	<b>B-164</b>	<b>HS-164</b>	<b>HB-164</b>	<b>TS-3</b>
<b>B-SCY</b>	14 x 7 10 x 7	Boys Yoke Cuff	<b>BP-33</b> <b>BP-715</b>	<b>B-33</b> <b>B-715</b>	<b>HS-33</b> <b>HS-715</b>	<b>HB-33</b> <b>HB-715</b>	<b>TS-4</b> (Set of 2)
<b>CC-C</b> (PC327)	20 1/2 x 9 1/2 13 x 7	Collar/Yoke Cuff	<b>BP-43</b> <b>BP-20</b>	<b>B-43</b> <b>B-20</b>	<b>HS-43</b> <b>HS-20</b>	<b>HB-43</b> <b>HB-20</b>	<b>TS-5</b> (Set of 2)
<b>CCG</b>	20 1/2 x 6 11 1/4 x 11 x 6 1/2	Collar Gusset Cuffs (2)	<b>BP-81</b> <b>BP-484</b>	<b>B-81</b> <b>B-484</b>	<b>HS-81</b> <b>HS-484</b>	<b>HB-81</b> <b>HB-484</b>	<b>TS-7</b> (Set of 3)
<b>CCW</b> <b>CCW-C</b> (PC310) <b>CCW-S</b> (PC321)	21 x 7 13 x 7	Collar Cuffs (2)	<b>BP-72**</b> <b>BP-20**</b>	<b>B-72**</b> <b>B-20**</b>	<b>HS-72**</b> <b>HS-20**</b>	<b>HB-72</b> <b>HB-20</b>	<b>TS-8</b> (Set of 3)
			<b>CPDB-1</b> — Collar Rest Cover/Pad				
<b>CCW-CX</b> <b>Center Pleat</b>	19 x 9 8 x 10 1/2 x 6 1/2 8 x 10 1/2 x 6 1/2	Collar Left Cuff Right Cuff	<b>BP-1821</b> <b>BP-1825</b> <b>BP-1826</b>	<b>B-1821</b> <b>B-1825</b> <b>B-1826</b>	<b>HS-1821</b> <b>HS-1825</b> <b>HS-1826</b>	<b>HB-1821</b> <b>HB-1825</b> <b>HB-1826</b>	<b>TS-575</b> (Set of 3)
			<b>CPDB-1</b> — Collar Rest Cover/Pad				
<b>CCW-CX</b> <b>Offset Pleat</b>	19 x 9 8 x 10 1/2 x 6 1/2 8 x 10 1/2 x 6 1/2	Collar Left Cuff Right Cuff	<b>BP-1821</b> <b>BP-1823</b> <b>BP-1824</b>	<b>B-1821</b> <b>B-1823</b> <b>B-1824</b>	<b>HS-1821</b> <b>HS-1823</b> <b>HS-1824</b>	<b>HB-1821</b> <b>HB-1823</b> <b>HB-1824</b>	<b>TS-572</b> (Set of 3)
			<b>CPDB-1</b> — Collar Rest Cover/Pad				
<b>CCY</b> <b>CCY-C</b> (PC311)	20 x 10 x 7 13 1/2 x 7	Collar/Yoke Cuffs (2)	<b>BP-43</b> <b>BP-23</b>	<b>B-43</b> <b>B-23</b>	<b>HS-43</b> <b>HS-23</b>	<b>HB-43</b> <b>HB-23</b>	<b>TS-9</b> (Set of 3)
<b>COAS</b> <b>COIM</b> <b>COM</b> <b>COMS</b>	35 1/2 x 17 1/2 x 10 1/2	Coin-Op Legger	<b>BP-183</b>	<b>B-183</b>	<b>HS-183</b>	<b>HB-183</b>	<b>TS-10</b>
<b>KCCW-C</b> (PC314)	21 x 7 x 6 13 1/2 x 7	Collar Cuffs (2) (Electric)	<b>N/A</b> <b>N/A</b> <b>CPDB-1</b>	<b>N/A</b> <b>N/A</b> Collar Rest Cover/Pad	<b>HS-72**</b> <b>HS-20**</b>	<b>HB-72</b> <b>HB-20</b>	<b>TS-8</b> (Set of 3)
<b>K-SBB</b>	30 x 14 1/2	Body Bosom (Electric)	<b>N/A</b>	<b>N/A</b>	<b>HS-166</b>	<b>HB-166</b>	<b>TS-11</b>

**CCW-CX**  
CENTER PLEAT

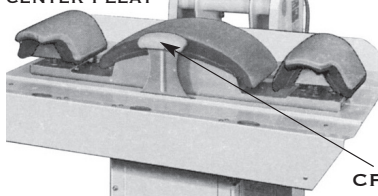

**CPDB-1**

**\*\* For Skirted  
Tie-On Covers  
order the following:**  
Collar      89  
Cuffs (2)    24

**\* SPECIFY BARE BUCK  
or OVER SPRINGS**

# LAUNDRY



## AJAX/ALLIANCE/AMERICAN/ACECO/MARTIN FLATBED PRESSES

MFG. MODEL NUMBER	BUCK SIZE	DESCRIPTION	COMBO	COVERS		PADS		
			BONPAK NYLON COVER/ PAD	BON-SPUN NYLON	HI-SPUN ARAMID	50 OZ. BONN-E- BLUE	TEXSTEEL STEEL BASE PAD*	
<b>KSCY</b>	18 1/2 x 8 1/2 13 x 7 (Electric)	Collar/Yoke Cuff	N/A N/A	N/A N/A	HS-43 HS-20	HB-43 HB-20	TS-12 (Set of 2)	
<b>MM-BB</b>	30 1/2 x 14	BodyBosom	<b>BP-166</b>	<b>B-166</b>	<b>HS-166</b>	<b>HB-166</b>	<b>TS-1</b>	
<b>MM-CCY</b> (PC327)	20 1/2 x 9 1/2 13 x 7	Collar/Yoke Cuff	<b>BP-43</b> <b>BP-20</b>	<b>B-43</b> <b>B-20</b>	<b>HS-43</b> <b>HS-20</b>	<b>HB-43</b> <b>HB-20</b>	<b>TS-5</b> (Set of 2)	
<b>MTH</b>	20 1/2 x 7 13 x 7	Collar Cuffs (2)	<b>BP-72**</b> <b>BP-20**</b>	<b>B-72**</b> <b>B-20**</b>	<b>HS-72**</b> <b>HS-20**</b>	<b>HB-72</b> <b>HB-20</b>	<b>TS-13</b> (Set of 3)	
			<b>CPDB-1</b> — Collar Rest Cover/Pad					
<b>MTHG</b>	20 1/2 x 7 11 1/4 x 11 x 6 1/2	Collar Gussett Cuffs (2)	<b>BP-72</b> <b>BP-484</b>	<b>B-72</b> <b>B-484</b>	<b>HS-72</b> <b>HS-484</b>	<b>HB-72</b> <b>HB-484</b>	<b>TS-14</b> (Set of 3)	
			<b>CPDB-1</b> — Collar Rest Cover/Pad					
<b>NYT</b>	21 x 7 13 x 7	Collar Cuffs (2)	<b>BP-72**</b> <b>BP-20**</b>	<b>B-72**</b> <b>B-20**</b>	<b>HS-72**</b> <b>HS-20**</b>	<b>HB-72</b> <b>HB-20</b>	<b>TS-15</b> (Set of 3)	
			<b>CPDB-1</b> — Collar Rest Cover/Pad					
<b>SBB</b>	30 x 14 1/2	Body Bosom	<b>BP-166</b>	<b>B-166</b>	<b>HS-166</b>	<b>HB-166</b>	<b>TS-16</b>	
<b>SCY</b> <b>SCY-C</b> (PC313)	20 1/2 x 9 x 7 13 x 7	Collar/Yoke Cuff	<b>BP-43</b> <b>BP-20</b>	<b>B-43</b> <b>B-20</b>	<b>HS-43</b> <b>HS-20</b>	<b>HB-43</b> <b>HB-20</b>	<b>TS-12</b> (Set of 2)	
<b>SP-2-L</b>	23 x 11 x 7	Two Lay Sleever	<b>CP-458</b> Polyester Cover		<b>HB-458</b> 50 Oz. Bonn-E-Blue Pad		<b>TS-17</b>	
<b>CM-8</b>	18 x 8 1/2	Oval Mushroom	<b>BP-44</b>	<b>B-44</b>	<b>HS-44</b>	<b>HB-44</b>	<b>TS-18</b>	
<b>SS-10</b>	22 x 9 1/2	Yoke w/Cut-Out	<b>BP-119</b>	<b>B-119</b>	<b>HS-119</b>	<b>HB-119</b>	<b>TS-19</b>	
<b>DS-O 12</b> (631)	12 x 11 x 10 - Left 12 x 11 x 10-Right	Double Sleever	<b>BP-19</b> <b>BP-607</b>	<b>B-19</b> <b>B-607</b>	<b>HS-19</b> <b>HS-607</b>	<b>HB-19</b> <b>HB-607</b>	<b>TS-20</b> (Set of 2)	
<b>DY-017</b> (631)	16 x 10 x 7	Yoke w/Cut-Out	<b>BP-34</b>	<b>B-34</b>	<b>HS-34</b>	<b>HB-34</b>	<b>TS-21</b>	
<b>17-ECL-C</b> (PC293)	44 1/2 x 15 x 7	Long Collar (Electric)	N/A	N/A	<b>HS-770</b>	<b>HB-770</b>	<b>TS-22</b>	
<b>DM-O 18</b> (631)	18 x 10	Oval Mushroom	<b>BP-44</b>	<b>B-44</b>	<b>HS-44</b>	<b>HB-44</b>	<b>TS-555</b>	

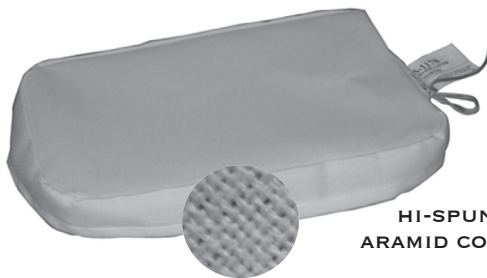

HI-SPUN  
ARAMID COVER

\*\* For Skirted  
Tie-On Covers  
order the following:  
Collar 89  
Cuffs (2) 24

\* SPECIFY BARE BUCK  
or OVER SPRINGS



## AJAX/ALLIANCE/AMERICAN/ACECO/MARTIN FLATBED PRESSES

MFG. MODEL NUMBER	BUCK SIZE	DESCRIPTION	COMBO	COVERS		PADS	
			BONPAK NYLON COVER/ PAD	BON-SPUN NYLON	HI-SPUN ARAMID	50 OZ. BONN-E- BLUE	TEXSTEEL STEEL BASE PAD*
<b>20</b>	22½ x 12	Oval Mushroom	<b>BP-102</b>	<b>B-102</b>	<b>HS-102</b>	<b>HB-102</b>	<b>TS-23</b>
<b>DM-O 20</b> (631)	21 x 13	Oval Mushroom	<b>BP-102</b>	<b>B-102</b>	<b>HS-102</b>	<b>HB-102</b>	<b>TS-24</b>
<b>DS-O 20</b> (631)	20 x 12 x 7	Yoke	<b>BP-94</b>	<b>B-94</b>	<b>HS-94</b>	<b>HB-94</b>	<b>TS-25</b>
<b>20½</b> (627)	22 x 6 x 7	Collar	<b>BP-105</b>	<b>B-105</b>	<b>HS-105</b>	<b>HB-105</b>	<b>TS-26</b>
<b>22</b>	21 x 10½	Yoke No Cut-Out	<b>BP-86</b>	<b>B-86</b>	<b>HS-86</b>	<b>HB-86</b>	<b>TS-27</b>
<b>22</b>	21 x 10½ x 5½	Yoke w/Cut-Out	<b>BP-87</b>	<b>B-87</b>	<b>HS-87</b>	<b>HB-87</b>	<b>TS-28</b>
<b>23</b>	21½ x 17½ x 10½ - Left 21½ x 17½ x 10½ - Right	Double Sleever	<b>BP-91</b>  <b>BP-92</b>	<b>B-91</b>  <b>B-92</b>	<b>HS-91</b>  <b>HS-92</b>	<b>HB-91</b>  <b>HB-92</b>	<b>TS-29</b> (Set of 2)
<b>DY-O 23</b> (631)	23 x 11 x 6	Yoke w/Cut-Out	<b>BP-119</b>	<b>B-119</b>	<b>HS-119</b>	<b>HB-119</b>	<b>TS-31</b>
<b>24</b>	18 x 9	Oval Mushroom	<b>BP-44</b>	<b>B-44</b>	<b>HS-44</b>	<b>HB-44</b>	<b>TS-32</b>
<b>29</b> (627)	26½ x 12	Collar/Lapel	<b>BP-152</b>	<b>B-152</b>	<b>HS-152</b>	<b>HB-152</b>	<b>TS-33</b>
<b>33-6</b> (627)	12 x 8	Cuffs (2)	<b>BP-20</b>	<b>B-20</b>	<b>HS-20</b>	<b>HB-20</b>	<b>TS-34</b> (Set of 2)
<b>33-6-G</b>	13 x 12 x 7	Gusset Cuffs (2)	<b>BP-29</b>	<b>B-29</b>	<b>HS-29</b>	<b>HB-29</b>	<b>TS-35</b> (Set of 2)
<b>33-7</b> (627)	20 x 7 13 x 7	Collar Cuffs (2)	<b>BP-105</b> <b>BP-20</b>	<b>B-105</b> <b>B-20</b>	<b>HS-105</b> <b>HS-20</b>	<b>HB-105</b> <b>HB-20</b>	<b>TS-36</b> (Set of 3)
<b>33-7-GB</b> (611)	21 x 7 13½ x 11½ x 7½	Collar Gusset Cuffs (2)	<b>BP-105</b> <b>BP-29</b>	<b>B-105</b> <b>B-29</b>	<b>HS-105</b> <b>HS-29</b>	<b>HB-105</b> <b>HB-29</b>	<b>TS-37</b> (Set of 3)
<b>33-7-GB</b> (627)	21 x 7 13½ x 11½ x 7½	Collar Gusset Cuffs (2)	<b>BP-105</b> <b>BP-484</b>	<b>B-105</b> <b>B-484</b>	<b>HS-105</b> <b>HS-484</b>	<b>HB-105</b> <b>HB-484</b>	<b>TS-38</b> (Set of 3)
<b>33-9</b> (627)	20 x 7 13½ x 11½ x 7½	Collar Gusset Cuffs (2)	<b>BP-105</b> <b>BP-484</b>	<b>B-105</b> <b>B-484</b>	<b>HS-105</b> <b>HS-484</b>	<b>HB-105</b> <b>HB-484</b>	<b>TS-39</b> (Set of 3)
<b>36</b>	36 x 18 x 10	Tapered Legger	<b>BP-186</b>	<b>B-186</b>	<b>HS-186</b>	<b>HB-186</b>	<b>TS-40</b>

\* SPECIFY BARE BUCK  
or OVER SPRINGS

# LAUNDRY



## AJAX/ALLIANCE/AMERICAN/ACECO/MARTIN FLATBED PRESSES

MFG. MODEL NUMBER	BUCK SIZE	DESCRIPTION	COMBO	COVERS		PADS	
			BONPAK NYLON COVER/ PAD	BON-SPUN NYLON	HI-SPUN ARAMID	50 OZ. BONN-E- BLUE	TEXSTEEL STEEL BASE PAD*
<b>36</b> (627)	36 x 18 x 10	Tapered Legger	<b>BP-186</b>	<b>B-186</b>	<b>HS-186</b>	<b>HB-186</b>	<b>TS-41</b>
<b>37</b>	37 x 12 <sup>1</sup> / <sub>2</sub>	Double End Pants Topper	<b>BP-191</b>	<b>B-191</b>	<b>HS-191</b>	<b>HB-191</b>	<b>TS-42</b>
<b>37</b> (627)	37 x 12 <sup>1</sup> / <sub>2</sub>	Double End Pants Topper	<b>BP-191</b>	<b>B-191</b>	<b>HS-191</b>	<b>HB-191</b>	<b>TS-43</b>
<b>38</b>	37 x 13 x 8 <sup>1</sup> / <sub>2</sub>	Tapered	<b>BP-200</b>	<b>B-200</b>	<b>HS-200</b>	<b>HB-200</b>	<b>TS-44</b>
<b>40-C</b>	38 <sup>1</sup> / <sub>2</sub> x 18 <sup>1</sup> / <sub>2</sub>	Body Bosom	<b>BP-198</b>	<b>B-198</b>	<b>HS-198</b>	<b>HB-198</b>	<b>TS-45</b>
<b>40-C</b> (627)	38 <sup>1</sup> / <sub>2</sub> x 18 <sup>1</sup> / <sub>2</sub>	Body Bosom	<b>BP-198</b>	<b>B-198</b>	<b>HS-198</b>	<b>HB-198</b>	<b>TS-46</b>
<b>NY-40</b>	39 <sup>1</sup> / <sub>2</sub> x 18	Body Bosom	<b>BP-204</b>	<b>B-204</b>	<b>HS-204</b>	<b>HB-204</b>	<b>TS-47</b>
<b>41</b>	41 x 18	Body Bosom	<b>BP-208</b>	<b>B-208</b>	<b>HS-208</b>	<b>HB-208</b>	<b>TS-49</b>
<b>42</b>	42 <sup>1</sup> / <sub>2</sub> x 19 x 13 <sup>1</sup> / <sub>2</sub>	Legger w/Cut-Out	<b>BP-214</b>	<b>B-214</b>	<b>HS-214</b>	<b>HB-214</b>	<b>TS-50</b>
<b>42-T</b>	42 x 24	Rectangular	<b>BP-213</b>	<b>B-213</b>	<b>HS-213</b>	<b>HB-213</b>	<b>TS-51</b>
<b>Ajax 51</b>	51 x 17	Rectangular	<b>BP-239</b>	<b>B-239</b>	<b>HS-239</b>	<b>HB-239</b>	<b>TS-52</b>
<b>51</b>	51 x 19 x 9 <sup>1</sup> / <sub>2</sub>	Tapered	<b>BP-234</b>	<b>B-234</b>	<b>HS-234</b>	<b>HB-234</b>	<b>TS-53</b>
<b>51</b> (627)	51 x 19 x 10	Tapered	<b>BP-234</b>	<b>B-234</b>	<b>HS-234</b>	<b>HB-234</b>	<b>TS-54</b>
<b>51-A</b>	52 x 19 x 11	Tapered	<b>BP-241</b>	<b>B-241</b>	<b>HS-241</b>	<b>HB-241</b>	<b>TS-55</b>
<b>51-A</b> (627)	53 x 19 x 11	Tapered	<b>BP-241</b>	<b>B-241</b>	<b>HS-241</b>	<b>HB-241</b>	<b>TS-56</b>
<b>51-38</b>	51 x 16 x 8	Tapered	<b>BP-233</b>	<b>B-233</b>	<b>HS-233</b>	<b>HB-233</b>	<b>TS-57</b>
<b>51-38</b> (627)	51 x 15 x 8	Tapered	<b>BP-233</b>	<b>B-233</b>	<b>HS-233</b>	<b>HB-233</b>	<b>TS-58</b>
<b>52</b>	52 x 17	Rectangular	<b>BP-239</b>	<b>B-239</b>	<b>HS-239</b>	<b>HB-239</b>	<b>TS-59</b>
<b>52</b>	50 x 18 x 13	Tapered	<b>BP-241</b>	<b>B-241</b>	<b>HS-241</b>	<b>HB-241</b>	<b>TS-60</b>
<b>53</b>	52 x 18	Rectangular	<b>BP-239</b>	<b>B-239</b>	<b>HS-239</b>	<b>HB-239</b>	<b>TS-61</b>

\* SPECIFY BARE BUCK  
or OVER SPRINGS



## AJAX/ALLIANCE/AMERICAN/ACECO/MARTIN FLATBED PRESSES

MFG. MODEL NUMBER	BUCK SIZE	DESCRIPTION	COMBO	COVERS		PADS	
			BONPAK NYLON COVER/ PAD	BON-SPUN NYLON	HI-SPUN ARAMID	50 OZ. BONN-E- BLUE	TEXSTEEL STEEL BASE PAD*
<b>54-G</b>	53 x 24 x 20	Rectangular w/Cut-Outs	<b>BP-249</b>	<b>B-249</b>	<b>HS-249</b>	<b>HB-249</b>	<b>TS-62</b>
<b>54-SK</b>	57½ x 31 x 20	Coat	<b>BP-255</b>	<b>B-255</b>	<b>HS-255</b>	<b>HB-255</b>	<b>TS-63</b>
<b>54-T</b>	54 x 24	Rectangular	<b>BP-263</b>	<b>B-263</b>	<b>HS-263</b>	<b>HB-263</b>	<b>TS-64</b>
<b>54-T</b> (627)	53 x 24	Rectangular	<b>BP-263</b>	<b>B-263</b>	<b>HS-263</b>	<b>HB-263</b>	<b>TS-65</b>
<b>54½</b>	53 x 17 x 13	Tapered	<b>BP-264</b>	<b>B-264</b>	<b>HS-264</b>	<b>HB-264</b>	<b>TS-66</b>
<b>54½</b> (627)	53 x 18 x 13	Tapered	<b>BP-264</b>	<b>B-264</b>	<b>HS-264</b>	<b>HB-264</b>	<b>TS-67</b>
<b>55</b>	54 x 19	Rectangular	<b>BP-254</b>	<b>B-254</b>	<b>HS-254</b>	<b>HB-254</b>	<b>TS-68</b>
<b>55</b> (627)	54 x 18	Rectangular	<b>BP-254</b>	<b>B-254</b>	<b>HS-254</b>	<b>HB-254</b>	<b>TS-69</b>
<b>56</b>	54 x 20½	Rectangular	<b>BP-260</b>	<b>B-260</b>	<b>HS-260</b>	<b>HB-260</b>	<b>TS-70</b>
<b>103-A</b>	21 x 12 x 5	Flat Iron	<b>BP-66</b>	<b>B-66</b>	<b>HS-66</b>	<b>HB-66</b>	<b>TS-71</b>
<b>106</b>	18 x 9½	Oval Mushroom	<b>BP-44</b>	<b>B-44</b>	<b>HS-44</b>	<b>HB-44</b>	<b>TS-72</b>
<b>106-A</b>	17 x 9	Oval Mushroom	<b>BP-44</b>	<b>B-44</b>	<b>HS-44</b>	<b>HB-44</b>	<b>TS-73</b>
<b>107</b>	20½ x 12	Oval Mushroom	<b>BP-102</b>	<b>B-102</b>	<b>HS-102</b>	<b>HB-102</b>	<b>TS-74</b>
<b>107-A</b>	20½ x 12	Oval Mushroom	<b>BP-102</b>	<b>B-102</b>	<b>HS-102</b>	<b>HB-102</b>	<b>TS-76</b>
<b>109</b>	17 x 9 x 4½	Yoke w/Cut-Out	<b>BP-34</b>	<b>B-34</b>	<b>HS-34</b>	<b>HB-34</b>	<b>TS-77</b>
<b>111-A</b>	20 x 12	Yoke	<b>BP-59</b>	<b>B-59</b>	<b>HS-59</b>	<b>HB-59</b>	<b>TS-556</b>
<b>113-A</b>	24 x 12 x 8	2-Lay Sleever	<b>CP-458</b> Polyester Cover <b>HB-458</b> 50 Oz. Bonn-E-Blue Pad				<b>TS-557</b>
<b>114-B</b>	13½ x 11½ x 7½	Gusset Cuffs (2)	<b>BP-29</b>	<b>B-29</b>	<b>HS-29</b>	<b>HB-29</b>	<b>TS-78</b> (Set of 2)
<b>114-C</b>	11½ x 7½	Cuffs (2)	<b>BP-20</b>	<b>B-20</b>	<b>HS-20</b>	<b>HB-20</b>	<b>TS-79</b> (Set of 2)

\* SPECIFY BARE BUCK  
or OVER SPRINGS



BP - BON-TWILL COVER WITH 50 OZ. PAD

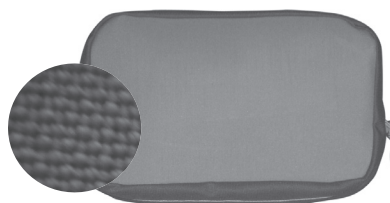

BON-SPUN NYLON COVER

# LAUNDRY



## AJAX/ALLIANCE/AMERICAN/ACECO/MARTIN FLATBED PRESSES

MFG. MODEL NUMBER	BUCK SIZE	DESCRIPTION	COMBO	COVERS		PADS	
			BONPAK NYLON COVER/ PAD	BON-SPUN NYLON	HI-SPUN ARAMID	50 OZ. BONN-E- BLUE	TEXSTEEL STEEL BASE PAD*
<b>114-SS</b>	12 x 7 <sup>1</sup> / <sub>2</sub>	Cuffs (2)	<b>BP-20</b>	<b>B-20</b>	<b>HS-20</b>	<b>HB-20</b>	<b>TS-80</b> (Set of 2)
<b>115</b>	22 <sup>1</sup> / <sub>2</sub> x 7	Collar	<b>BP-105</b>	<b>B-105</b>	<b>HS-105</b>	<b>HB-105</b>	<b>TS-81</b>
<b>116<sup>1</sup>/<sub>2</sub></b>	26 <sup>3</sup> / <sub>4</sub> x 12 x 6 <sup>3</sup> / <sub>4</sub>	Collar/Lapel	<b>BP-152</b>	<b>B-152</b>	<b>HS-152</b>	<b>HB-152</b>	<b>TS-82</b>
<b>117</b>	21 x 10 <sup>1</sup> / <sub>2</sub> x 5 <sup>1</sup> / <sub>2</sub>	Yoke w/Cut-Out	<b>BP-87</b>	<b>B-87</b>	<b>HS-87</b>	<b>HB-87</b>	<b>TS-83</b>
<b>117-B</b>	22 <sup>1</sup> / <sub>4</sub> x 11 x 5 <sup>1</sup> / <sub>2</sub>	Yoke w/Cut-Out	<b>BP-119</b>	<b>B-119</b>	<b>HS-119</b>	<b>HB-119</b>	<b>TS-84</b>
<b>118</b>	20 <sup>1</sup> / <sub>4</sub> x 11 x 5 <sup>1</sup> / <sub>2</sub>	Yoke	<b>BP-78</b>	<b>B-78</b>	<b>HS-78</b>	<b>HB-78</b>	<b>TS-85</b>
<b>DM-120</b> (631)	19 x 10	Oval Mushroom	<b>BP-51</b>	<b>B-51</b>	<b>HS-51</b>	<b>HB-51</b>	<b>TS-86</b>
<b>121-MR</b>	21 x 14 <sup>1</sup> / <sub>2</sub> x 8	Flat Iron	<b>BP-96</b>	<b>B-96</b>	<b>HS-96</b>	<b>HB-96</b>	<b>TS-87</b>
<b>DY-121</b> (631)	21 x 10 x 6	Yoke w/Cut-Out	<b>BP-85</b>	<b>B-85</b>	<b>HS-85</b>	<b>HB-85</b>	<b>TS-88</b>
<b>B-136</b>	35 x 20	Body Bosom	<b>BP-177</b>	<b>B-177</b>	<b>HS-177</b>	<b>HB-177</b>	<b>TS-89</b>
<b>BB-136</b>	35 x 20	Body Bosom	<b>BP-177</b>	<b>B-177</b>	<b>HS-177</b>	<b>HB-177</b>	<b>TS-90</b>
<b>140-A</b>	40 x 17	Body Bosom	<b>BP-198</b>	<b>B-198</b>	<b>HS-198</b>	<b>HB-198</b>	<b>TS-91</b>
<b>140-B</b>	40 x 18	Body Bosom	<b>BP-208</b>	<b>B-208</b>	<b>HS-208</b>	<b>HB-208</b>	<b>TS-92</b>
<b>142-A</b>	42 x 19	Body Bosom	<b>BP-210</b>	<b>B-210</b>	<b>HS-210</b>	<b>HB-210</b>	<b>TS-93</b>
<b>218-C</b> (PC281)	18 x 8 <sup>1</sup> / <sub>2</sub>	Oval Mushroom	<b>BP-44</b>	<b>B-44</b>	<b>HS-44</b>	<b>HB-44</b>	<b>TS-94</b>
<b>218-MR</b>	18 x 8 <sup>1</sup> / <sub>2</sub>	Oval Mushroom	<b>BP-44</b>	<b>B-44</b>	<b>HS-44</b>	<b>HB-44</b>	<b>TS-95</b>
<b>219</b>	21 x 9	Oval Mushroom	<b>BP-67</b>	<b>B-67</b>	<b>HS-67</b>	<b>HB-67</b>	<b>TS-96</b>
<b>220<sup>1</sup>/<sub>2</sub></b> (627)	20 x 7 x 6	Double Collar (2)	<b>BP-105</b>	<b>B-105</b>	<b>HS-105</b>	<b>HB-105</b>	<b>TS-97</b> (Set of 2)
<b>221</b>	21 x 13	Oval Mushroom	<b>BP-102</b>	<b>B-102</b>	<b>HS-102</b>	<b>HB-102</b>	<b>TS-98</b>

\* SPECIFY BARE BUCK  
OR OVER SPRINGS

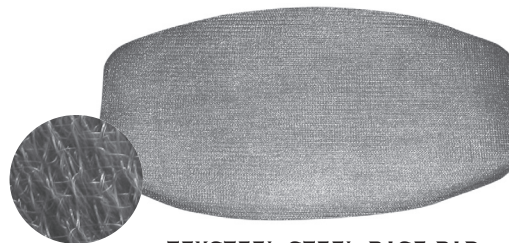

TEXSTEEL STEEL BASE PAD



## AJAX/ALLIANCE/AMERICAN/ACECO/MARTIN FLATBED PRESSES

MFG. MODEL NUMBER	BUCK SIZE	DESCRIPTION	COMBO	COVERS		PADS	
			BONPAK NYLON COVER/ PAD	BON-SPUN NYLON	HI-SPUN ARAMID	50 OZ. BONN-E- BLUE	TEXSTEEL STEEL BASE PAD*
<b>222</b> <b>222-C</b> (PC280)	20 x 10	Oval Mushroom	<b>BP-51</b>	<b>B-51</b>	<b>HS-51</b>	<b>HB-51</b>	<b>TS-99</b>
<b>BB-234</b>	35 x 20	Body Bosom	<b>BP-177</b>	<b>B-177</b>	<b>HS-177</b>	<b>HB-177</b>	<b>TS-100</b>
<b>B-236</b>	35 x 20	Body Bosom	<b>BP-177</b>	<b>B-177</b>	<b>HS-177</b>	<b>HB-177</b>	<b>TS-101</b>
<b>BB-236</b>	35 x 20	Body Bosom	<b>BP-177</b>	<b>B-177</b>	<b>HS-177</b>	<b>HB-177</b>	<b>TS-102</b>
<b>EB-236</b>	35 x 20	Body Bosom	<b>BP-177</b>	<b>B-177</b>	<b>HS-177</b>	<b>HB-177</b>	<b>TS-103</b>
<b>BB-240</b>	39 x 19	Body Bosom	<b>BP-198</b>	<b>B-198</b>	<b>HS-198</b>	<b>HB-198</b>	<b>TS-104</b>
<b>BB-240-C</b> (PC312)	39 x 19	Body Bosom w/Slit No Slit	<b>BP-198</b> <b>BP-202</b>	<b>B-198</b> <b>B-202</b>	<b>HS-198</b> <b>HS-202</b>	<b>HB-198</b> <b>HB-202</b>	<b>TS-104</b>
<b>PC260</b> (2442-C)	42 x 24	Rectangular	<b>BP-213</b>	<b>B-213</b>	<b>HS-213</b>	<b>HB-213</b>	<b>TS-105</b>
<b>PC280</b> (222-C)	20 x 10	Oval Mushroom	<b>BP-51</b>	<b>B-51</b>	<b>HS-51</b>	<b>HB-51</b>	<b>TS-99</b>
<b>PC281</b> (218-C)	18 x 8½	Oval Mushroom	<b>BP-44</b>	<b>B-44</b>	<b>HS-44</b>	<b>HB-44</b>	<b>TS-94</b>
<b>PC290</b> (1057PY-C)	20½ x 12	Yoke	<b>BP-78</b>	<b>B-78</b>	<b>HS-78</b>	<b>HB-78</b>	<b>TS-106</b>
<b>PC291</b> (438-C)	38 x 12 x 9	Tapered	<b>BP-196</b>	<b>B-196</b>	<b>HS-196</b>	<b>HB-196</b>	<b>TS-108</b>
<b>PC292</b> (451-C)	50 x 18 x 9	Tapered	<b>BP-230</b>	<b>B-230</b>	<b>HS-230</b>	<b>HB-230</b>	<b>TS-109</b>
<b>PC293</b> (17ECL-C)	44½ x 15 x 7	Long Collar (Electric)	<b>N/A</b>	<b>N/A</b>	<b>HS-770</b>	<b>HB-770</b>	<b>TS-22</b>
<b>PC294</b> (1854)	54 x 18	Rectangular	<b>BP-254</b>	<b>B-254</b>	<b>HS-254</b>	<b>HB-254</b>	<b>TS-110</b>
<b>PC295</b> (554-C)	54 x 19 x 11	Tapered	<b>BP-258</b>	<b>B-258</b>	<b>HS-258</b>	<b>HB-258</b>	<b>TS-111</b>
<b>PC296</b> (3612-C)	36 x 12	Double End Pants Topper	<b>BP-184</b>	<b>B-184</b>	<b>HS-184</b>	<b>HB-184</b>	<b>TS-112</b>

\* SPECIFY BARE BUCK  
or OVER SPRINGS

# LAUNDRY



## AJAX/ALLIANCE/AMERICAN/ACECO/MARTIN FLATBED PRESSES

MFG. MODEL NUMBER	BUCK SIZE	DESCRIPTION	COMBO	COVERS		PADS	TEXSTEEL STEEL BASE PAD*
			BONPAK NYLON COVER/ PAD	BON-SPUN NYLON	HI-SPUN ARAMID	50 OZ. BONN-E- BLUE	
<b>PC310</b> (CCW-C)	21 x 7 x 6 13 x 7	Collar Cuffs (2)	<b>BP-72**</b> <b>BP-20**</b>	<b>B-72**</b> <b>B-20**</b>	<b>HS-72**</b> <b>HS-20**</b>	<b>HB-72</b> <b>HB-20</b>	<b>TS-8</b> (Set of 3)
<b>PC311</b> (CCY-C)	20 x 10 x 7 13 x 7	Collar/Yoke Cuffs (2)	<b>BP-43</b> <b>BP-20</b>	<b>B-43</b> <b>B-20</b>	<b>HS-43</b> <b>HS-20</b>	<b>HB-43</b> <b>HB-20</b>	<b>TS-9</b> (Set of 3)
<b>PC312</b> (BB-240-C)	39 x 19	Body Bosom	<b>BP-198</b>	<b>B-198</b>	<b>HS-198</b>	<b>HB-198</b>	<b>TS-104</b>
<b>PC313</b> (SCY-C)	20½ x 9 x 7 13 x 7	Collar/Yoke Cuff	<b>BP-43</b> <b>BP-20</b>	<b>B-43</b> <b>B-20</b>	<b>HS-43</b> <b>HS-20</b>	<b>HB-43</b> <b>HB-20</b>	<b>TS-12</b> (Set of 2)
<b>PC314</b> (KCCW-C)	21 x 7 x 6 13½ x 7	Collar Cuffs (2) (Electric)	<b>N/A</b> <b>N/A</b>	<b>N/A</b> <b>N/A</b>	<b>HS-72**</b> <b>HS-20**</b>	<b>HB-72</b> <b>HB-20</b>	<b>TS-8</b> (Set of 3)
<b>PC315</b> (541813-C)	54 x 18 x 13	Tapered	<b>BP-264</b>	<b>B-264</b>	<b>HS-264</b>	<b>HB-264</b>	<b>TS-113</b>
<b>D-317</b>	16 x 11	Yoke w/Cut-Out	<b>BP-34</b>	<b>B-34</b>	<b>HS-34</b>	<b>HB-34</b>	<b>TS-114</b>
<b>PC318</b> (2990-C)	90 x 29	Flatwork Rectangular	<b>BP-420</b>	<b>B-420</b>	<b>HS-420</b>	<b>HB-420</b>	<b>TS-115</b>
<b>PC319</b> (29110-C)	110 x 29	Flatwork Rectangular	<b>BP-427</b>	<b>B-427</b>	<b>HS-427</b>	<b>HB-427</b>	<b>TS-117</b>
<b>321</b>	21½ x 10½	Yoke w/Cut-Out	<b>BP-85</b>	<b>B-85</b>	<b>HS-85</b>	<b>HB-85</b>	<b>TS-118</b>
<b>PC321</b> (CCW-S)	21 x 7 x 6 13 x 7	Collar Cuffs (2)	<b>BP-72**</b> <b>BP-20**</b>	<b>B-72**</b> <b>B-20**</b>	<b>HS-72**</b> <b>HS-20**</b>	<b>HB-72</b> <b>HB-20</b>	<b>TS-8</b> (Set of 3)
<b>D-323</b>	23 x 11½	Yoke w/Cut-Out	<b>BP-119</b>	<b>B-119</b>	<b>HS-119</b>	<b>HB-119</b>	<b>TS-119</b>
<b>PC327</b> (CC-C)	20½ x 9½ 13 x 7	Collar/Yoke Cuff	<b>BP-43</b> <b>BP-20</b>	<b>B-43</b> <b>B-20</b>	<b>HS-43</b> <b>HS-20</b>	<b>HB-43</b> <b>HB-20</b>	<b>TS-5</b> (Set of 2)
<b>PC330</b> (BB-C)	30½ x 14	Body Bosom	<b>BP-166</b>	<b>B-166</b>	<b>HS-166</b>	<b>HB-166</b>	<b>TS-1</b>

**\*\* For Skirted  
Tie-On Covers  
order the following:  
Collar           89  
Cuffs (2)       24**

**\* SPECIFY BARE BUCK  
or OVER SPRINGS**



**50 OZ. BONN-E-  
BLUE PAD**



## AJAX/ALLIANCE/AMERICAN/ACECO/MARTIN FLATBED PRESSES

MFG. MODEL NUMBER	BUCK SIZE	DESCRIPTION	COMBO	COVERS		PAD	TEXSTEEL STEEL BASE PAD*
			BONPAK NYLON COVER/ PAD	BON-SPUN NYLON	HI-SPUN ARAMID	50 OZ. BONN-E- BLUE	
<b>438</b> <b>438-C</b> (PC291)	38 x 12 x 9	Tapered	<b>BP-196</b>	<b>B-196</b>	<b>HS-196</b>	<b>HB-196</b>	<b>TS-108</b>
<b>450</b>	50 x 17 x 8	Tapered	<b>BP-233</b>	<b>B-233</b>	<b>HS-233</b>	<b>HB-233</b>	<b>TS-120</b>
<b>451</b> <b>451-C</b> (PC292)	50 x 18 x 9	Tapered	<b>BP-230</b>	<b>B-230</b>	<b>HS-230</b>	<b>HB-230</b>	<b>TS-109</b>
<b>454</b>	54 x 19 x 11	Tapered	<b>BP-258</b>	<b>B-258</b>	<b>HS-258</b>	<b>HB-258</b>	<b>TS-121</b>
<b>552</b>	52 x 18	Rectangular	<b>BP-239</b>	<b>B-239</b>	<b>HS-239</b>	<b>HB-239</b>	<b>TS-122</b>
<b>554</b> <b>554-C</b> (PC295)	54 x 19 x 11	Tapered	<b>BP-258</b>	<b>B-258</b>	<b>HS-258</b>	<b>HB-258</b>	<b>TS-111</b>
<b>740</b>	40 x 7	Chef's Hat	<b>BP-711</b>	<b>B-711</b>	<b>HS-711</b>	<b>HB-711</b>	<b>TS-123</b>
<b>829-A</b>	26 x 12 x 6	Collar/Lapel	<b>BP-152</b>	<b>B-152</b>	<b>HS-152</b>	<b>HB-152</b>	<b>TS-124</b>
<b>830</b>	26 x 12 x 6	Collar/Lapel	<b>BP-152</b>	<b>B-152</b>	<b>HS-152</b>	<b>HB-152</b>	<b>TS-125</b>
<b>840</b>	18 x 7	Collar	<b>BP-72</b>	<b>B-72</b>	<b>HS-72</b>	<b>HB-72</b>	<b>TS-126</b>
<b>841-A</b>	21½ x 6 13 x 6	Collar Cuffs (2)	<b>BP-72**</b> <b>BP-20**</b>	<b>B-72**</b> <b>B-20**</b>	<b>HS-72**</b> <b>HS-20**</b>	<b>HB-72</b> <b>HB-20</b>	<b>TS-127</b> (Set of 3)
<b>842-A</b>	21½ x 7	Double Collar (2)	<b>BP-72</b>	<b>B-72</b>	<b>HS-72</b>	<b>HB-72</b>	<b>TS-128</b> (Set of 2)
<b>843</b>	13 x 7	Cuffs (2)	<b>BP-20</b>	<b>B-20</b>	<b>HS-20</b>	<b>HB-20</b>	<b>TS-129</b> (Set of 2)
<b>843-G</b>	13 x 10½ x 6½/2	Gusset Cuffs (2)	<b>BP-484</b>	<b>B-484</b>	<b>HS-484</b>	<b>HB-484</b>	<b>TS-136</b> (Set of 2)
<b>1019-LS</b>	19 x 10½	Yoke w/Cut-Out	<b>BP-54</b>	<b>B-54</b>	<b>HS-54</b>	<b>HB-54</b>	<b>TS-141</b>

\*\* For Skirted Tie-On Covers  
order the following:  
Collar 89  
Cuffs (2) 24

\* SPECIFY BARE BUCK  
or OVER SPRINGS

# LAUNDRY



## AJAX/ALLIANCE/AMERICAN/ACECO/MARTIN FLATBED PRESSES

MFG. MODEL NUMBER	BUCK SIZE	DESCRIPTION	COMBO	COVERS		PADS	
			BONPAK NYLON COVER/ PAD	BON-SPUN NYLON	HI-SPUN ARAMID	50 OZ. BONN-E- BLUE	TEXSTEEL STEEL BASE PAD*
<b>1020</b>	20 x 10	Yoke	<b>BP-78</b>	<b>B-78</b>	<b>HS-78</b>	<b>HB-78</b>	<b>TS-142</b>
<b>1021-LS</b>	21 x 10	Yoke w/Cut-Out	<b>BP-87</b>	<b>B-87</b>	<b>HS-87</b>	<b>HB-87</b>	<b>TS-143</b>
<b>1057</b> <b>1057PY-C</b> (PC290)	20½ x 12	Yoke	<b>BP-78</b>	<b>B-78</b>	<b>HS-78</b>	<b>HB-78</b>	<b>TS-106</b>
<b>1112</b>	12 x 11 x 10 - Left 12 x 11 x 10 - Right	Double Short Sleeve	<b>BP-19</b> <b>BP-607</b>	<b>B-19</b> <b>B-607</b>	<b>HS-19</b> <b>HS-607</b>	<b>HB-19</b> <b>HB-607</b>	<b>TS-144</b> (Set of 2)
<b>1121</b>	21 x 18 x 10 - Left 21 x 18 x 10 - Right	Double Sleever	<b>BP-91</b> <b>BP-92</b>	<b>B-91</b> <b>B-92</b>	<b>HS-91</b> <b>HS-92</b>	<b>HB-91</b> <b>HB-92</b>	<b>TS-145</b> (Set of 2)
<b>1126</b>	26 x 23 x 13 - Left 26 x 23 x 13 - Right	Double Sleever	<b>BP-563</b> <b>BP-564</b>	<b>B-563</b> <b>B-564</b>	<b>HS-563</b> <b>HS-564</b>	<b>HB-563</b> <b>HB-564</b>	<b>TS-146</b> (Set of 2)
<b>1137</b>	11 x 10 x 7 - Left 22 x 19 x 11 - Right	Double Utility and Sleever	<b>BP-13</b> <b>BP-113</b>	<b>B-13</b> <b>B-113</b>	<b>HS-13</b> <b>HS-113</b>	<b>HB-13</b> <b>HB-113</b>	<b>TS-147</b> (Set of 2)
<b>1852</b>	52 x 18	Rectangular	<b>BP-239</b>	<b>B-239</b>	<b>HS-239</b>	<b>HB-239</b>	<b>TS-148</b>
<b>1854</b> <b>1854-C</b> (PC294)	54 x 18	Rectangular	<b>BP-254</b>	<b>B-254</b>	<b>HS-254</b>	<b>HB-254</b>	<b>TS-110</b>
<b>1954</b>	54 x 19	Rectangular	<b>BP-254</b>	<b>B-254</b>	<b>HS-254</b>	<b>HB-254</b>	<b>TS-151</b>
<b>2052</b>	52 x 20	Rectangular	<b>BP-242</b>	<b>B-242</b>	<b>HS-242</b>	<b>HB-242</b>	<b>TS-152</b>
<b>2054</b>	54 x 20	Rectangular	<b>BP-260</b>	<b>B-260</b>	<b>HS-260</b>	<b>HB-260</b>	<b>TS-153</b>
<b>2254</b>	54 x 22	Rectangular	<b>BP-247</b>	<b>B-247</b>	<b>HS-247</b>	<b>HB-247</b>	<b>TS-155</b>
<b>2263</b>	63 x 22	Rectangular	<b>BP-295</b>	<b>B-295</b>	<b>HS-295</b>	<b>HB-295</b>	<b>TS-156</b>
<b>2264</b>	64 x 22	Rectangular	<b>BP-295</b>	<b>B-295</b>	<b>HS-295</b>	<b>HB-295</b>	<b>TS-157</b>
<b>2440</b>	40 x 24	Rectangular	<b>BP-213</b>	<b>B-213</b>	<b>HS-213</b>	<b>HB-213</b>	<b>TS-158</b>
<b>2442</b> <b>2442-C</b> (PC260)	42 x 24	Rectangular	<b>BP-213</b>	<b>B-213</b>	<b>HS-213</b>	<b>HB-213</b>	<b>TS-105</b>

\* SPECIFY BARE BUCK  
or OVER SPRINGS



## AJAX/ALLIANCE/AMERICAN/ACECO/MARTIN FLATBED PRESSES

MFG. MODEL NUMBER	BUCK SIZE	DESCRIPTION	COMBO	COVERS		PADS	
			BONPAK NYLON COVER/ PAD	BON-SPUN NYLON	HI-SPUN ARAMID	50 OZ. BONN-E- BLUE	TEXSTEEL STEEL BASE PAD*
<b>2454</b>	54 x 24	Rectangular	<b>BP-265</b>	<b>B-265</b>	<b>HS-265</b>	<b>HB-265</b>	<b>TS-562</b>
<b>2460</b>	60 x 24	Drapery Rectangular	<b>BP-278</b>	<b>B-278</b>	<b>HS-278</b>	<b>HB-278</b>	<b>TS-160</b>
<b>2990-C</b> (PC318) <b>2990-FW</b>	90 x 29	Flatwork Rectangular	<b>BP-420</b>	<b>B-420</b>	<b>HS-420</b>	<b>HB-420</b>	<b>TS-115</b>
<b>3612</b> <b>3612-C</b> (PC296)	36 x 12	Double End Pants Topper	<b>BP-184</b>	<b>B-184</b>	<b>HS-184</b>	<b>HB-184</b>	<b>TS-112</b>
<b>3614</b>	36 x 14	Double End Pants Topper	<b>BP-187</b>	<b>B-187</b>	<b>HS-187</b>	<b>HB-187</b>	<b>TS-161</b>
<b>51-38</b>	51 x 16 x 9	Tapered	<b>BP-233</b>	<b>B-233</b>	<b>HS-233</b>	<b>HB-233</b>	<b>TS-162</b>
<b>29110-C</b> (PC319) <b>29110-FW</b>	110 x 29	Flatwork Rectangular	<b>BP-427</b>	<b>B-427</b>	<b>HS-427</b>	<b>HB-427</b>	<b>TS-117</b>
<b>75418</b>	54 x 18 x 7	Tapered Navy	<b>BP-244</b>	<b>B-244</b>	<b>HS-244</b>	<b>HB-244</b>	<b>TS-164</b>
<b>361811</b>	36 x 18 x 11	Coin-Op Legger	<b>BP-183</b>	<b>B-183</b>	<b>HS-183</b>	<b>HB-183</b>	<b>TS-165</b>
<b>541813</b> <b>541813-C</b> (PC315)	54 x 18 x 13	Tapered	<b>BP-264</b>	<b>B-264</b>	<b>HS-264</b>	<b>HB-264</b>	<b>TS-113</b>

\* SPECIFY BARE BUCK  
or OVER SPRINGS



**3612**  
**3612-C**



HI-SPUN ARAMID COVER

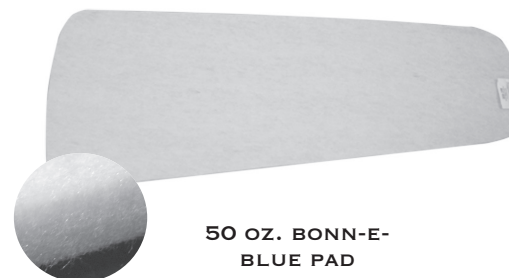

50 OZ. BONN-E-  
BLUE PAD

# LAUNDRY



## APEX SHIRT FINISHER

MFG. MODEL NUMBER	WHITE KNIT COVER	50 OZ. BONN-E-BLUE PAD	AIR BAG	TUCK COVER/PAD	SHORT SLEEVE CLAMP COVER	SILICONE BASE PAD
80S	WK-1816	HB-1816	1818*	WKFB-1822*	1856**	RS-1816

\* Requires 2

\*\* Requires 4

## BARBANTI COLLAR & CUFF

MFG. MODEL NUMBER	BUCK SIZE	DESCRIPTION	WHITE ARAMID COVER/PAD	SILICONE BASE PAD
510	25 1/2 x 7 1/2	Collar	WADB-2204	CS-2204
	15 x 7 1/2	Cuffs (2)	WADB-2207	(Set of 3)



## CISSELL CABINET BOSOM PRESSES

MFG. MODEL NUMBER	DESCRIPTION	COVERS		FLANNEL PADS				TEXSTEEL STEEL BASE PAD
		SPRING LOADED YOKE WHITE SIDES	WHITE SIDES	50 OZ. PRYME	30 OZ. PRYME	50 OZ. BONN-E-BLUE	30 OZ. BONN-E-BLUE	
CUSBV 18"	SINGLE VACUUM	AW-521	AW-324	N/A	F-1684	N/A	FB-1684	TS-1684
CUDBV 18"	DOUBLE VACUUM							
CUSDV 20"	SINGLE VACUUM	AW-533	AW-352	N/A	F-1683	N/A	FB-1683	TS-1683

## CISSELL CABINET SLEEVE PRESSES

MFG. MODEL NUMBER	DESCRIPTION	COVERS		PADS			
		PFW/ OVERSIZED WHITE SIDES	PFW/ WHITE SIDES	20 OZ STOCKING BONN-E-BLUE PAD	TEXSTEEL STEEL BASE PAD (SET OF 2)	SPRING PAD ASSEMBLY (SET OF 4)	CLEAN BOOT
CUS	Mens	PFW-1789*	PFW-154*	DB-153*	Set TS-154	Set SPA-154	M-801*
CUSB	Boys	N/A	N/A	DB-47*	Set TS-48	N/A	N/A

\* Requires 2

- The 20 oz. slip-over stocking BONN-E-BLUE pad (**DB-153 & DB-47**) is designed for use over worn steel base pads.
- TEXSTEEL steel base pads (**SET TS-154 & SET TS-48**) are enclosed with heat resistant zip-on material for easy installation.
- Clean Boots (**M-801**) should be installed to keep clean shirts away from smudges at base of Sleever.

## POST SLEEVER

MFG. MODEL NUMBER	DESCRIPTION	HI-SPUN WHITE ARAMID COVER W/DFN (GUSSET)	AIR RETENTION BOOTS
ACI-1231	Post Sleever	HTD-6*	M-1695*

\* Requires 2

# LAUNDRY



## CISSELL HOT AIR SHIRT FINISHERS

MFG. MODEL NUMBER	PF SHIRT FORM COVER	CLAMP COVER	CLAMP PAD	BON-SPUN AIR SKIRT COVER	BON-SPUN BREAST COVER	BON-SPUN NECK COVER	COLLAR PLATE COVER/PAD
LUNA	PF-1364	HS-1384	N/A	B-1386	B-1382	B-1383	N/A
VENUS	PF-959	HS-1208	D-1208	N/A	N/A	N/A	PFD-1360

## CISSELL FLATBED PRESSES

MFG. MODEL NUMBER	BUCK SIZE	DESCRIPTION	COMBO		COVERS		PADS	TEXSTEEL STEEL BASE PAD*
			BONPAK NYLON COVER/PAD		BON-SPUN NYLON	HI-SPUN ARAMID	50 OZ. BONN-E-BLUE	
19 LP	18 x 8 1/2	Oval Mushroom	BP-44		B-44	HS-44	HB-44	TS-94
51 LP	50 x 18 1/2 x 9 1/4	Tapered	BP-230		B-230	HS-230	HB-230	TS-109
53 LP	53 1/4 x 18 x 10 1/2	Tapered	BP-258		B-258	HS-258	HB-258	TS-111
ACI-1193	19 x 9 1/2	Oval Mushroom	BP-51		B-51	HS-51	HB-51	N/A
ACI-1401	40 x 19	Body Bosom	BP-1323		B-1323	HS-1323	HB-1323	N/A
ACI-1402	30 x 14 x 11	Body Bosom	BP-166		B-166	BP-166	HB-166	N/A
ACI-1445	21 x 8 12 x 7	Collar/Yoke Cuff	BP-73 BP-17		B-73 B-17	HS-73 HS-17	HB-73 HB-17	N/A N/A
ACI-1455	18 x 9 1/2 12 x 6	Collar Cuffs (2)	BP-1325 BP-1324		B-1325 B-1324	HS-1325 HS-1324	HB-1325 HB-1324	N/A N/A
ACI-1505	49 x 19 x 9	Tapered	BP-230		B-230	HS-230	HB-230	N/A
ACI-1541	53 x 20	Rectangular	BP-260		B-260	HS-260	HB-260	N/A

\* SPECIFY BARE BUCK  
or OVER SPRINGS



BP - BON-TWILL COVER WITH 50 OZ. PAD



HI-SPUN  
ARAMID COVER

**COLMAC  
EQUIPMENT**

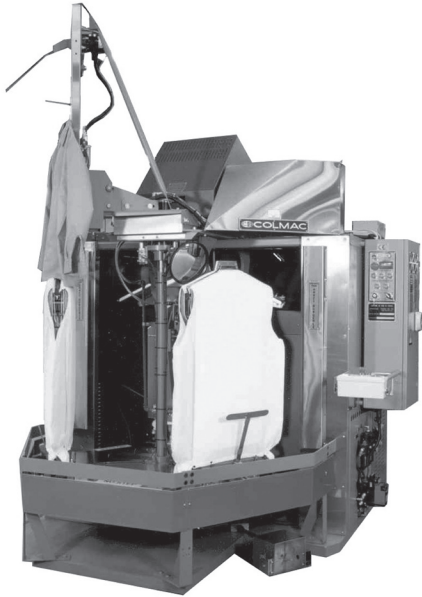

**3 CPU-TRIPLE BUCK  
SHIRT UNIT**



**LASER SLEEVER**



**PANT-A-MATIC  
PANT PRESS**



**PCCOA COLLAR &  
CUFF UNIT**



**TRIPLE CONNIE LAB  
COAT FINISHER**



## COLMAC SHIRT PRESSES & COLLAR & CUFF UNITS

MFG. MODEL NUMBER	DESCRIPTION	DESCRIPTION	COVERS		PADS		TEXSTEEL STEEL BASE PAD
			HI-SPUN ARAMID	BON-SPUN NYLON	50 OZ. BONN-E- BLUE	FLAN-O WOOL METAL FLANNEL	
<b>167-C</b>	Connie	Front	<b>HS-616</b>	N/A	<b>HB-616</b>	<b>FOW-616</b>	<b>TS-616</b>
		Rear	<b>HS-617</b>	N/A	<b>HB-617</b>	<b>FOW-617</b>	<b>TS-617</b>
<b>168-C</b>	Connie	Front	<b>HS-616</b>	N/A	<b>HB-616</b>	<b>FOW-616</b>	<b>TS-616</b>
		Rear	<b>HS-617</b>	N/A	<b>HB-617</b>	<b>FOW-617</b>	<b>TS-617</b>
		Clamp Cover	<b>HS-1031</b>	N/A	N/A	N/A	N/A
<b>PCCOA</b>	Collar & Cuff Unit	Collar Cuffs (2)	<b>HS-1179</b> <b>HS-1178</b>	<b>B-1179</b> <b>B-1178</b>	<b>HB-1179</b> <b>HB-1178</b>	N/A N/A	<b>TS-1985</b> (Set of 3)
<b>TSU</b> <b>TSP-II</b> <b>TSP-III</b> <b>TSP-IV</b>	Triple Buck Shirt Unit	Front	<b>HS-721</b>	N/A	<b>HB-721</b>	<b>FOW-721</b>	<b>TS-721</b>

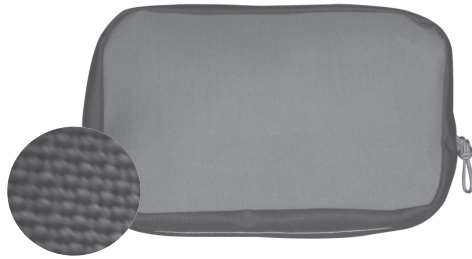

BON-SPUN NYLON COVER



HI-SPUN  
ARAMID COVER

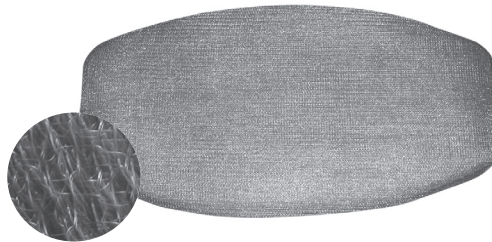

TEXSTEEL STEEL BASE PAD



## COLMAC

### CABINET AIR BAG BODY PRESSES

MFG. MODEL NUMBER	DESCRIPTION	WHITE KNIT OUTER COVER with 30 OZ. Flannel WKFB-723	INSIDE COVER W/AIR BAGS OWP-723	TEXSTEEL STEEL BASE PAD TS-723
<b>3CPU</b> <b>3CPU Plus</b>	Triple Buck Shirt Unit	WKFB-723	OWP-723	TS-723
<b>DOUBLE CONNIE</b> <b>TRIPLE CONNIE</b> <b>Turbo</b>	Lab Coat Finisher	WKFB-1753	OWP-1754	TS-1754

### CABINET AIR BAG SLEEVERS

MFG. MODEL NUMBER	DESCRIPTION	LEFT HAND BAG COVER W/FLANNEL BUILD-UP 1501D	RIGHT HAND BAG COVER W/FLANNEL BUILD-UP 1502D	AIR BAGS 1500*	BUCK COVERS C-1528*
<b>LASER</b>	Air Bag Sleever	1501D	1502D	1500*	C-1528*

\* Requires 2

MFG. MODEL NUMBER	DESCRIPTION	AIR BAGS 1544*	20 OZ. STOCKING PAD DB-1544*
<b>LASER 1</b>	Air Bag Sleever	1544*	DB-1544*

\* Requires 2

**3CPU &  
3CPU PLUS  
COVER/PAD &  
AIR BAG**



**OWP-723**



**WKFB-723**



**TRIPLE CONNIE  
LAB COAT FINISHER**

# LAUNDRY



## COLMAC PANT-A-MATIC

MFG. MODEL NUMBER	DESCRIPTION	COVERS		PADS		TEXSTEEL STEEL BASE PAD
		HI-SPUN ARAMID	HI-SPUN ARAMID W/50 OZ. PAD	50 OZ. BONN-E-BLUE		
<b>800</b>	Leg (Zipper Cover)	<b>HS-800</b>	<b>N/A</b>	<b>HB-800</b>		<b>TS-800</b>
<b>900</b>	Fly	<b>HS-618</b>	<b>HHB-618</b>	<b>N/A</b>		<b>TS-618</b>
<b>1100</b>	Left Pocket	<b>HS-488</b>	<b>HHB-488</b>	<b>N/A</b>		<b>TS-488</b>
<b>1138</b>	Right Pocket	<b>HS-489</b>	<b>HHB-489</b>	<b>N/A</b>		<b>TS-489</b>
<b>1200</b>	Left Rear Pocket	<b>HS-490</b>	<b>HHB-490</b>	<b>N/A</b>		<b>TS-490</b>
	Right Rear Pocket	<b>HS-491</b>	<b>HHB-491</b>	<b>N/A</b>		<b>TS-491</b>

MFG. MODEL NUMBER	DESCRIPTION	COVERS		PAD	
		HI-SPUN ARAMID	POLYESTER	50OZ. BONN-E-BLUE PAD	FLY COVER
<b>1400</b>	Pant-a-Matic Pant Press	<b>HS-1881</b>	<b>CP-1881</b>	<b>HB-1881</b>	<b>CP-1882*</b>

\* Requires 2

MFG. MODEL NUMBER	DESCRIPTION	HI-SPUN ARAMID CENTER BUCK COVER	50 OZ. BONN-E-BLUE PAD	HI-SPUN ARAMID SIDE CHEST COVERS	FLY CLAMP COVER	TEXSTEEL STEEL BASE PAD
<b>2660</b>	Pant-a-Matic Pant Press	<b>HS-2226</b>	<b>HB-1881</b>	<b>Set 2228 (set of 2)</b>	<b>B-2234</b>	<b>TS-2226</b>

PANT-A-MATIC  
PANTS PRESS  
1400



# LAUNDRY



## FIMAS COLLAR & CUFF

		COVERS		PAD
MFG. MODEL NUMBER	DESCRIPTION	BON-SPUN NYLON	HI-SPUN ARAMID	500Z. BONN-E-BLUE PAD
387	Collar	B-2342	HS-2342	HB-2342
	Cuffs (2)	B-2338	HS-2338	HB-2338



**FORENTA  
EQUIPMENT**



27VCY



32VB



4224VL



51VL



## FORENTA CABINET BOSOM PRESSES

MFG. MODEL NUMBER	DESCRIPTION	COVERS			FLANNEL PADS			DELUXE HI-SPUN Insulation Boot**	TEXSTEEL STEEL BASE PAD	EXPANDER TYPE (See Below)
		BON-DAC	BON-SPUN NYLON	HI-SPUN ARAMID	30 OZ. BONN-E-BLUE	50 OZ. BONN-E-BLUE				
100-VBM	SINGLE	N/A	B-360	HS-360	FB-360	HB-360	K-360		TS-360	359
110-VBM	SINGLE	A-537	B-537	HS-537	FB-537	HB-537	K-537		TS-365	364, 422, 359, or 628
180-BM 190-BM 200-BM 300-HB	SINGLE ↓	A-537	B-537	HS-537	FB-537	HB-537	K-537		TS-537	628 or 1673
190-BME	SINGLE (Electric)									
510-SB 515-SB 520-DB 530-DB	SINGLE DOUBLE	A-537	B-537	HS-537	FB-537	HB-537	K-510		TS-510	1673
880-BM	DOUBLE									

\*\* Boot is included with FLAN-O-WOOL Pads.

## EXPANDERS FOR THE ABOVE CABINET BOSOM PRESSES

COVERS		(A)	(B)	(C)
HI-SPUN ARAMID COVER	BON-SPUN NYLON COVER			
HS-359*	B-359*	6 1/2"	25 1/2"	5"
HS-364*	B-364*	6"	23"	5"
HS-422*	B-422*	6 1/2"	23 1/2"	6 1/2"
HS-536*	B-536*	5 1/2"	23"	4 1/2"
HS-628*	B-628*	6"	21 1/2"	5 1/2"
HS-1673*	B-1673*	6 3/4"	21 1/2"	6"

\* Requires 2



FLAN-O-WOOL

HI-SPUN INSULATION BOOT IS INCLUDED WITH FLAN-O-WOOL METAL FLANNEL PADS

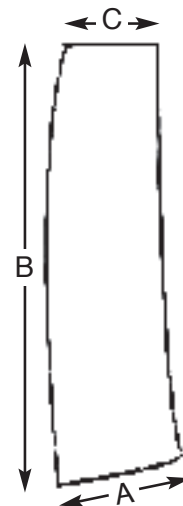

# LAUNDRY



## FORENTA CABINET BOSOM PRESSES

MFG. MODEL NUMBER	DESCRIPTION	COVERS		FLANNEL PADS		TEXSTEEL STEEL BASE PAD
		SPRING LOADED YOKE WHITE SIDE	WHITE SIDES	30 OZ. BONN-E-BLUE	50 OZ. BONN-E-BLUE	
801 SBA 811 SBA	MAGNA SINGLE	AW-1934	AW-1937	FB-1934	HB-1934	TS-1934
801 SBV 811-SBV 802 DBV	MAGNA SINGLE VACUUM MAGNA DOUBLE VACUUM	AW-1930	AW-1936	FB-1930	HB-1930	TS-1930
802 DBA	MAGNA DOUBLE	AW-1934	AW-1937	FB-1934	HB-1934	TS-1934

## FORENTA CABINET BOSOM PRESSES

MFG. MODEL NUMBER	DESCRIPTION	STEEL WOOL YOKE WHITE SIDE	30 OZ. FLANNEL PAD W/ VACUUM BARRIER	PLEAT COVER/ PAD	MOVING SHORT SLEEVE GRIPPER COVER	FIXED SHORT SLEEVE GRIPPER COVER	TEXSTEEL STEEL BASE PAD
821 SBSP	MAGNA BODY/ SLEEVE PRESS	AW-2570	FB-2570	2590*	2587*	2589*	TS-2570
822 SBSP	MAGNA BODY/ SLEEVE PRESS	AW-2701	FB-2570	2705- Left 2706- Right	2587*	2589*	TS-2570

\* Requires 2

## CABINET AIR BAG

MFG. MODEL NUMBER	DESCRIPTION	COVERS		PADS			CUFF CLAMP COVER/ PAD	SHORT SLEEVE COVER FRONT	SHORT SLEEVE COVER REAR	TEXSTEEL STEEL BASE PAD
		*SPRING LOADED YOKE WHITE SIDES	WHITE SIDES	30 OZ. BONN-E-BLUE	50 OZ. BONN-E-BLUE					
840 SBSP	MAGNA SINGLE w/PLEATERS	AW-1984	AW-1980	FB-1984	HB-1984	S-1981*	DB-1723**	1725*	1979*	TS-1984
850 RDSP	MAGNA DOUBLE w/PLEATERS									

\* Requires 2

\*\*Requires 4



## FORENTA/FORSE CABINET SLEEVE PRESSES

MFG. MODEL NUMBER	DESCRIPTION	PF COVER W/AIR BAGS	20 OZ. BONN-E-BLUE PAD W/DRAW CORDS	TEXSTEEL STEEL BASE PAD (Set/4)
910 SAB	MAGNA	PF-2140*	DB-1928*	Set TS-1928

\* Requires 2

## CABINET AIR BAG SLEEVER

MFG. MODEL NUMBER	COVERS				PADS		TEXSTEEL STEEL BASE PAD (SET OF 4)
	HI-SPUN ARAMID COVER W/ AIR BAGS	HI-SPUN ARAMID COVER W/ HEAVY DUTY AIR BAGS	HI-SPUN ARAMID COVER W/ AIR BAGS & CUFF BLOCKS	HI-SPUN ARAMID COVER W/ HEAVY DUTY AIR BAGS & CUFF BLOCKS	30 OZ. DFN NYLON PAD	CUFF BLOCK COVER	
902-HSA 905-HSA 905-HSA (Bravo)	HS-1685*	HS-1687*	HS-1686*	HS-1692*	F-1685*	WK-1685*	Set TS-1397

\* Requires 2

## CABINET AIR BAG BODY PRESSES

MFG. MODEL NUMBER	DESCRIPTION	TOP FLANNEL					TEXSTEEL STEEL BASE PAD
		OUTER COVER	PRYME FLANNEL	30 OZ. BONN-E-BLUE	INSIDE COVER W/ AIR BAGS		
510-SBA	SINGLE	A-1689	D-1689	N/A	OWP-1688 or 1714*	TS-510A	
510-SBV	SINGLE VACUUM	A-1689	D-1689	N/A	OWP-1688 or 1714*	TS-510V	
520-DBA	DOUBLE	A-1689	D-1689	N/A	OWP-1688 or 1714*	TS-510A	
520-DBV	DOUBLE VACUUM	A-1689	D-1689	N/A	OWP-1688 or 1714*	TS-510V	
610-SBA	SINGLE	A-1717	F-1717	FB-1717	OWP-1715	TS-610A	
610-SBV	SINGLE VACUUM	A-1717	F-1717	FB-1717	OWP-1715	TS-610V	
620-DBA	DOUBLE	A-1717	F-1717	FB-1717	OWP-1715	TS-610A	
620-DBV	DOUBLE VACUUM	A-1717	F-1717	FB-1717	OWP-1715	TS-610V	
660-BSV 661-BSV	SINGLE VACUUM	A-1717	F-1717	FB-1717	OWP-1716	TS-610V	

\* IMPORTANT: For presses manufactured prior to 3/94, order OWP-1688. For presses manufactured after 3/1/94, order OWP-1714.



## FORENTA/FORSE SLEEVERS POST SLEEVER

MFG. MODEL NUMBER	HI-SPUN ARAMID W/DFN (GUSSET)	WHITE VINYL SNAP-ON TYPE	WHITE VINYL WIRE/CLIP TYPE	HI-SPUN ARAMID KNOB COVER/PAD	PLUTO AIR DEFLECTOR STRAP	TEXSTEEL STEEL BASE PAD (Set of 2)
65-SL 75-SL 76-SLS	HTD-6*	M-374*	M-373*	OJUL-1344*	PL-1656*	Set TS-6
75-SLEV (Electric)	HTD-6*	M-374*	M-373*	OJUL-1344*	JUL-1656*	Set TS-6

\* Requires 2

## STEAM & AIR SHIRT BAG SLEEVER

MFG. MODEL NUMBER	SLEEVER AIR BAG COVER	ARAMID HEAT CHAMBER BASE COVER
77SASL	2222*	BAJUH-2223*

\* Requires 2

## FLEX WING SLEEVER

MFG. MODEL NUMBER	BON-DAC SLEEVE COVER	FRONT EXPANDER HI-SPUN ARAMID COVER/PAD (24 1/2 x 3 3/4 x 3)	FRONT PF W/21 OZ. DFN PAD "CONVERTED" (24 x 4 1/4 x 2)	REAR EXPANDER HI-SPUN ARAMID COVER/PAD	HI-SPUN ARAMID KNOB COVER/PAD	TEXSTEEL STEEL BASE PAD (Set of 4)
771	A-687 (Requires 4)	HJUL-754 *	PFD-1398 *	HXOW-755 *	OJUL-1345 *	Set TS-687

\* Requires 2

## CABINET SLEEVER

MFG. MODEL NUMBER	PF OUTER SLEEVE COVER	PF W/30 OZ. DFN SLEEVE COVER/PAD	HI-SPUN ARAMID SLEEVE PAD	PF W/21 OZ. DFN FRONT EXPANDER COVER/PAD	PF W/21 OZ. DFN REAR EXPANDER COVER/PAD	HI-TEMP WHITE VINYL AIR RETENTION BOOTS	TEXSTEEL STEEL BASE PAD (Set of 4)
901-HBS**	PF-1396*	N/A	HJUL-1397 (Requires 4)	PFD-1398* (24 x 4 1/4 x 2)	PFD-1399* (24 1/4 x 4 1/4 x 2 1/4)	M-1670*	Set TS-1676
901-HBSB	N/A	AF-1676*	N/A	PFD-1677* (26 1/4 x 4 1/4 x 2)	PFD-1678* (26 1/4 x 3 1/2 x 1)	M-1670*	Set TS-1676
902-HSW	N/A	AF-1676*	N/A	PFD-1677* (26 1/4 x 4 1/4 x 2)	PFD-1678* (26 1/4 x 3 1/2 x 1)	M-1670*	Set TS-1397

\* Requires 2

\*\* **Important:** Some 901-HBS units have been converted with the #K-220 Conversion Kit. These units should use the cover and pads which are shown for the 901-HBSB.

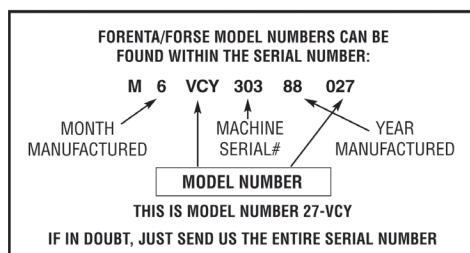



## FORENTA/FORSE FLATBED PRESSES

MFG. MODEL NUMBER	BUCK SIZE	DESCRIPTION	COMBO	COVERS		PADS	
			BONPAK NYLON COVER/ PAD	BON-SPUN NYLON	HI-SPUN ARAMID	50 OZ. BONN-E- BLUE	TEXSTEEL STEEL BASE PAD BARE BUCK
<b>18-FM</b>	18 x 9	Oval Mushroom	<b>BP-102</b>	<b>B-102</b>	<b>HS-102</b>	<b>HB-102</b>	<b>TS-168</b>
<b>19-VM</b>	20½ x 10	Oval Mushroom	<b>BP-690</b>	<b>B-690</b>	<b>HS-690</b>	<b>HB-690</b>	<b>TS-173</b>
<b>19-VME</b>	20½ x 10	Oval Mushroom (Electric)	<b>N/A</b>	<b>N/A</b>	<b>HS-690</b>	<b>HB-690</b>	<b>TS-174</b>
<b>19-VS</b>	20½ x 10	Oval Mushroom	<b>BP-690</b>	<b>B-690</b>	<b>HS-690</b>	<b>HB-690</b>	<b>TS-175</b>
<b>19-VSE</b>	20½ x 10	Oval Mushroom (Electric)	<b>N/A</b>	<b>N/A</b>	<b>HS-690</b>	<b>HB-690</b>	<b>TS-176</b>
<b>20</b>	20½ x 11½	Flat Iron	<b>BP-101</b>	<b>B-101</b>	<b>HS-101</b>	<b>HB-101</b>	<b>TS-177</b>
<b>22</b>	21 x 12	Yoke	<b>BP-94</b>	<b>B-94</b>	<b>HS-94</b>	<b>HB-94</b>	<b>TS-178</b>
<b>23-FM</b>	21 x 10 x 6	Yoke	<b>BP-94</b>	<b>B-94</b>	<b>HS-94</b>	<b>HB-94</b>	<b>TS-179</b>
<b>24-VA</b>	11 x 10 x 7 - Left 11 x 10 x 7 - Right	Double Short Sleeve	<b>BP-13</b> <b>BP-14</b>	<b>B-13</b> <b>B-14</b>	<b>HS-13</b> <b>HS-14</b>	<b>HB-13</b> <b>HB-14</b>	<b>TS-180</b> (Set of 2)
<b>24-VAE</b>	11 x 10 x 7 - Left 11 x 10 x 7 - Right	Double Short Sleeve (Electric)	<b>N/A</b> <b>N/A</b>	<b>N/A</b> <b>N/A</b>	<b>HS-13</b> <b>HS-14</b>	<b>HB-13</b> <b>HB-14</b>	<b>TS-181</b> (Set of 2)
<b>26-VA</b>	11 x 11 x 8 - Left 11 x 11 x 8 - Right	Double Short Sleeve	<b>BP-494</b> <b>BP-790</b>	<b>B-494</b> <b>B-790</b>	<b>HS-494</b> <b>HS-790</b>	<b>HB-494</b> <b>HB-790</b>	<b>TS-183</b> (Set of 2)
<b>26-VS</b>	11 x 11 x 8 - Left 11 x 11 x 8 - Right	Double Short Sleeve	<b>BP-494</b> <b>BP-790</b>	<b>B-494</b> <b>B-790</b>	<b>HS-494</b> <b>HS-790</b>	<b>HB-494</b> <b>HB-790</b>	<b>TS-184</b> (Set of 2)
<b>27-VCY</b>	21 x 8 12 x 7	Collar/Yoke Cuff	<b>BP-73</b> <b>BP-17</b>	<b>B-73</b> <b>B-17</b>	<b>HS-73</b> <b>HS-17</b>	<b>HB-73</b> <b>HB-17</b>	<b>TS-185</b> (Set of 2)
<b>27-VCYB</b>	21 x 8 12 x 7	Collar/Yoke Cuff	<b>BP-46</b> <b>BP-17</b>	<b>B-46</b> <b>B-17</b>	<b>HS-46</b> <b>HS-17</b>	<b>HB-46</b> <b>HB-17</b>	<b>TS-186</b> (Set of 2)

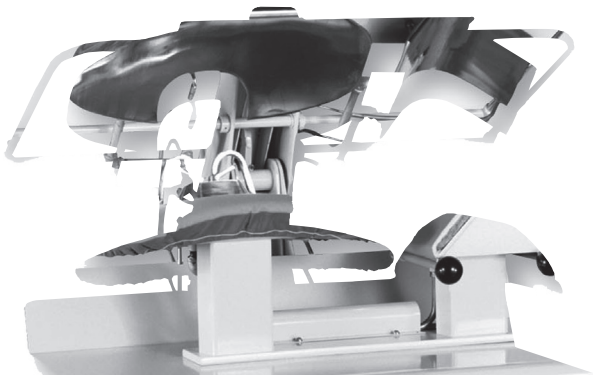

27-VCY

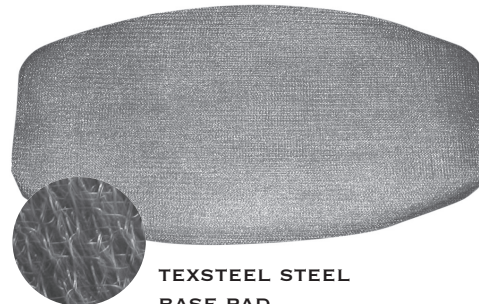

TEXSTEEL STEEL  
BASE PAD

# LAUNDRY



## FORENTA/FORSE FLATBED PRESSES

MFG. MODEL NUMBER	BUCK SIZE	DESCRIPTION	COMBO	COVERS		PADS	TEXSTEEL STEEL BASE PAD BARE BUCK
			BONPAK NYLON COVER/ PAD	BON-SPUN NYLON	HI-SPUN ARAMID	50 OZ. BONN-E- BLUE	
<b>27-VCYE</b>	21 x 8	Collar/Yoke	N/A	N/A	HS-73	HB-73	TS-185 (Set of 2)
	12 x 7	Cuff (Electric)	N/A	N/A	HS-17	HB-17	
<b>30-VA</b>	12 x 11 x 10 - Left	Double	BP-13	B-13	HS-13	HB-13	TS-187 (Set of 2)
	12 x 11 x 10 - Right	Short Sleeve	BP-14	B-14	HS-14	HB-14	
<b>32-MB</b>	30 x 14 x 11	Body Bosom	BP-166	B-166	HS-166	HB-166	TS-188
<b>32-MBE</b>	30 x 14 x 11	Body Bosom (Electric)	N/A	N/A	HS-166	HB-166	TS-189
<b>32-VB</b>	30 x 14 x 11	Body Bosom	BP-166	B-166	HS-166	HB-166	TS-166
<b>32-VBB</b>	29 x 14 x 11	Boy's Body Bosom	BP-164	B-164	HS-164	HB-164	TS-190
<b>32-VBBE</b>	29 x 14 x 11	Boy's Body Bosom (Electric)	N/A	N/A	HS-164	HB-164	TS-191
<b>32-VBE</b>	30 x 14 x 11	Body Bosom (Electric)	N/A	N/A	HS-166	HB-166	TS-192
<b>36-FYC</b>	20 1/2 x 10 1/2 x 7	Collar/Yoke	BP-94	B-94	HS-94	HB-94	TS-193 (Set of 3)
	12 x 7	Cuffs (2)	BP-20	B-20	HS-20	HB-20	
<b>36-VA</b>	11 x 10 x 7 - Left	Double	BP-13	B-13	HS-13	HB-13	TS-194 (Set of 2)
	21 x 18 x 11 - Right	Short Sleeve	BP-113	B-113	HS-113	HB-113	
<b>36-VAE</b>	11 x 10 x 7 - Left	Double	N/A	N/A	HS-13	HB-13	TS-195 (Set of 2)
	21 x 18 x 11 - Right	Short Sleeve (Electric)	N/A	N/A	HS-113	HB-113	
<b>37</b>	37 x 11 x 7	Tapered	BP-196	B-196	HS-196	HB-196	TS-196
<b>38-FGC</b>	21 x 7	Collar	BP-81	B-81	HS-81	HB-81	TS-197 (Set of 3)
	9 x 7	Cuffs (2)	BP-23	B-23	HS-23	HB-23	
<b>38-VAE</b>	12 x 11 x 10 - Left	Double	N/A	N/A	HS-494	HB-494	TS-198 (Set of 2)
	22 x 21 x 11 - Right	Short Sleeve (Electric)	N/A	N/A	HS-499	HB-499	

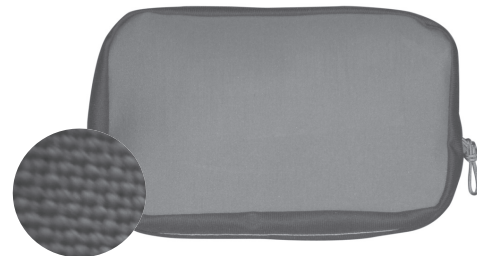
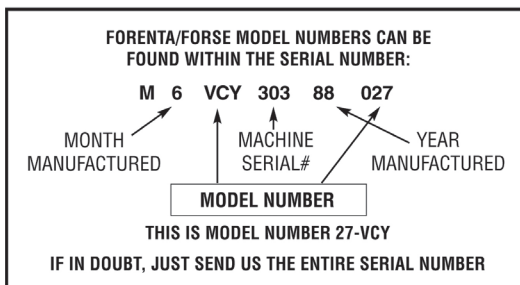

BON-SPUN NYLON COVER

# LAUNDRY



## FORENTA/FORSE FLATBED PRESSES

MFG. MODEL NUMBER	BUCK SIZE	DESCRIPTION	COMBO	COVERS		PADS	
			BONPAK NYLON COVER/ PAD	BON-SPUN NYLON	HI-SPUN ARAMID	50 OZ. BONN-E- BLUE	TEXSTEEL STEEL BASE PAD BARE BUCK
<b>38-VS</b>	12 x 11 x 10 - Left 22 x 21 x 11 - Right	Double Short Sleeve	<b>BP-494</b> <b>BP-499</b>	<b>B-494</b> <b>B-499</b>	<b>HS-494</b> <b>HS-499</b>	<b>HB-494</b> <b>HB-499</b>	<b>TS-199</b> (Set of 2)
<b>38-VSE</b>	12 x 11 x 10 - Left 22 x 21 x 11 - Right	Double Short Sleeve (Electric)	<b>N/A</b> <b>N/A</b>	<b>N/A</b> <b>N/A</b>	<b>HS-494</b> <b>HS-499</b>	<b>HB-494</b> <b>HB-499</b>	<b>TS-200</b> (Set of 2)
<b>39-C</b>	21 x 8 12 x 7	Collar Cuffs (2)	<b>BP-105</b> <b>BP-20</b>	<b>B-105</b> <b>B-20</b>	<b>HS-105</b> <b>HS-20</b>	<b>HB-105</b> <b>HB-20</b>	<b>TS-201</b> (Set of 3)
<b>39-HV</b>	21 x 7 12 x 7	Collar/Yoke Mustache Buck Cuffs (2)	<b>BP-95</b> <b>BP-30*</b>	<b>B-95</b> <b>B-30*</b>	<b>HS-95</b> <b>HS-30*</b>	<b>HB-95</b> <b>HB-30</b>	<b>TS-202</b> (Set of 3)
<b>39-HV</b>	21 x 7 12 x 7	Collar/Yoke T-Buck Cuffs (2)	<b>BP-79</b> <b>BP-30*</b>	<b>B-79</b> <b>B-30*</b>	<b>HS-79</b> <b>HS-30*</b>	<b>HB-79</b> <b>HB-30</b>	<b>TS-203</b> (Set of 3)
<b>39-SCS</b>	21 x 8 14 x 7	Collar Cuffs (2)	<b>BP-1331</b> <b>BP-1926**</b>	<b>B-1331</b> <b>B-1926**</b>	<b>HS-1331</b> <b>HS-1926**</b>	<b>HB-1331</b> <b>HB-1926</b>	<b>TS-1923</b> (Set of 3)
<b>39-SCSY</b>	21 x 7 14 x 7	Collar/Yoke Cuffs (2)	<b>BP-95</b> <b>BP-1926**</b>	<b>B-95</b> <b>B-1926**</b>	<b>HS-95</b> <b>HS-1926**</b>	<b>HB-95</b> <b>HB-1926</b>	<b>TS-1926</b> (Set of 3)
<b>39-SCSY-AS</b>	21 x 8 12 x 7	Collar/Yoke Cuffs (2)	<b>BP-95</b> <b>BP-2089</b>	<b>B-95</b> <b>B-2089</b>	<b>HS-95</b> <b>HS-2089</b>	<b>HB-95</b> <b>HB-2089</b>	<b>TS-2089</b> (Set of 3)
<b>39-VCC</b>	21 x 8 12 x 7	Collar Cuffs (2)	<b>BP-1331</b> <b>BP-17</b>	<b>B-1331</b> <b>B-17</b>	<b>HS-1331</b> <b>HS-17</b>	<b>HB-1331</b> <b>HB-17</b>	<b>TS-204</b> (Set of 3)
<b>39-VCCY</b>	21 x 7 12 x 7	Collar/Yoke Cuffs (2)	<b>BP-95</b> <b>BP-17</b>	<b>B-95</b> <b>B-17</b>	<b>HS-95</b> <b>HS-17</b>	<b>HB-95</b> <b>HB-17</b>	<b>TS-205</b> (Set of 3)
<b>39-VCH</b>	21 x 8 12 x 7	Collar Cuffs (2)	<b>BP-105</b> <b>BP-20</b>	<b>B-105</b> <b>B-20</b>	<b>HS-105</b> <b>HS-20</b>	<b>HB-105</b> <b>HB-20</b>	<b>TS-206</b> (Set of 3)
<b>39-VCHD</b>	21 x 8 12 x 7	Collar Cuffs (2)	<b>BP-1331</b> <b>BP-30*</b>	<b>B-1331</b> <b>B-30*</b>	<b>HS-1331</b> <b>HS-30*</b>	<b>HB-1331</b> <b>HB-30</b>	<b>TS-207</b> (Set of 3)
<b>39-VCHT</b>	21 x 8 12 x 7	Collar/Yoke Cuffs (2)	<b>BP-79</b> <b>BP-30*</b>	<b>B-79</b> <b>B-30*</b>	<b>HS-79</b> <b>HS-30*</b>	<b>HB-79</b> <b>HB-30</b>	<b>TS-208</b> (Set of 3)
<b>39-VCHY</b>	21 x 7 12 x 7	Collar/Yoke Cuffs (2)	<b>BP-95</b> <b>BP-30*</b>	<b>B-95</b> <b>B-30*</b>	<b>HS-95</b> <b>HS-30*</b>	<b>HB-95</b> <b>HB-30</b>	<b>TS-209</b> (Set of 3)

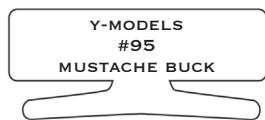
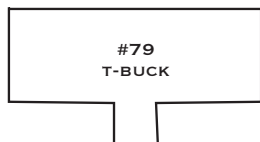

\* Cuff Covers w/Front Guard (30)  
Left Cuff: 1314  
Right Cuff: 1315  
(Requires 1 of each)

\*\* Cuff Covers w/Front Guard (1926)  
Left Cuff: 1953  
Right Cuff: 1955  
(Requires 1 of each)

# LAUNDRY



## FORENTA/FORSE FLATBED PRESSES

MFG. MODEL NUMBER	BUCK SIZE	DESCRIPTION	COMBO	COVERS		PADS	
			BONPAK NYLON COVER/ PAD	BON-SPUN NYLON	HI-SPUN ARAMID	50 OZ. BONN-E- BLUE	TEXSTEEL STEEL BASE PAD BARE BUCK
<b>41-FM</b>	40 x 19 x 8	Body Bosom	<b>BP-198</b>	<b>B-198</b>	<b>HS-198</b>	<b>HB-198</b>	<b>TS-210</b>
<b>44-VA</b>	11 x 10 x 7 - Left 29 x 26 x 11 - Right	Double Short Sleeve	<b>BP-13</b> <b>BP-168</b>	<b>B-13</b> <b>B-168</b>	<b>HS-13</b> <b>HS-168</b>	<b>HB-13</b> <b>HB-168</b>	<b>TS-211</b> (Set of 2)
<b>44-VAE</b>	11 x 10 x 7 - Left 29 x 26 x 11 - Right	Double Short Sleeve (Electric)	<b>N/A</b> <b>N/A</b>	<b>N/A</b> <b>N/A</b>	<b>HS-13</b> <b>HS-168</b>	<b>HB-13</b> <b>HB-168</b>	<b>TS-216</b> (Set of 2)
<b>45-VA</b>	12 x 11 x 10 - Left 29 x 26 x 11 - Right	Double Short Sleeve	<b>BP-494</b> <b>BP-168</b>	<b>B-494</b> <b>B-168</b>	<b>HS-494</b> <b>HS-168</b>	<b>HB-494</b> <b>HB-168</b>	<b>TS-217</b> (Set of 2)
<b>45-VS</b>	12 x 11 x 10 - Left 29 x 26 x 11 - Right	Double Short Sleeve	<b>BP-494</b> <b>BP-168</b>	<b>B-494</b> <b>B-168</b>	<b>HS-494</b> <b>HS-168</b>	<b>HB-494</b> <b>HB-168</b>	<b>TS-218</b> (Set of 2)
<b>51</b>	49 x 14 x 9	Tapered	<b>BP-233</b>	<b>B-233</b>	<b>HS-233</b>	<b>HB-233</b>	<b>TS-219</b>
<b>51-E</b>	50 x 14 1/2 x 8 1/4	Tapered (Electric)	<b>N/A</b>	<b>N/A</b>	<b>HS-233</b>	<b>HB-233</b>	<b>TS-220</b>
<b>51-VL</b>	50 x 14 1/2 x 8 1/4	Tapered	<b>BP-233</b>	<b>B-233</b>	<b>HS-233</b>	<b>HB-233</b>	<b>TS-221</b>
<b>51-VLE</b>	50 x 14 1/2 x 8 1/4	Tapered (Electric)	<b>N/A</b>	<b>N/A</b>	<b>HS-233</b>	<b>HB-233</b>	<b>TS-222</b>
<b>53</b>	53 x 19 x 11	Tapered	<b>BP-290</b>	<b>B-290</b>	<b>HS-290</b>	<b>HB-290</b>	<b>TS-223</b>
<b>53-VAE</b>	52 x 18 1/2 x 11 1/2	Tapered (Electric)	<b>N/A</b>	<b>N/A</b>	<b>HS-290</b>	<b>HB-290</b>	<b>TS-224</b>
<b>53-VAN</b>	52 x 18 1/2 x 11 1/2	Tapered	<b>BP-290</b>	<b>B-290</b>	<b>HS-290</b>	<b>HB-290</b>	<b>TS-225</b>
<b>53-VL</b>	52 x 18 1/2 x 11 1/2	Tapered	<b>BP-290</b>	<b>B-290</b>	<b>HS-290</b>	<b>HB-290</b>	<b>TS-226</b>
<b>53-VLE</b>	52 x 18 1/2 x 11 1/2	Tapered (Electric)	<b>N/A</b>	<b>N/A</b>	<b>HS-290</b>	<b>HB-290</b>	<b>TS-227</b>
<b>54-VAE</b>	53 x 18	Rectangular (Electric)	<b>N/A</b>	<b>N/A</b>	<b>HS-254</b>	<b>HB-254</b>	<b>TS-228</b>
<b>54-VL</b>	53 x 18	Rectangular	<b>BP-254</b>	<b>B-254</b>	<b>HS-254</b>	<b>HB-254</b>	<b>TS-229</b>

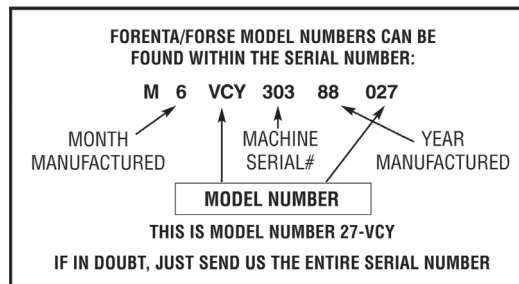



## FORENTA/FORSE FLATBED PRESSES

MFG. MODEL NUMBER	BUCK SIZE	DESCRIPTION	COMBO	COVERS		PADS	TEXSTEEL STEEL BASE PAD BARE BUCK
			BONPAK NYLON COVER/ PAD	BON-SPUN NYLON	HI-SPUN ARAMID	50 OZ. BONN-E- BLUE	
<b>54-VLDP</b> <b>54-VLVP</b>	53 x 18	Rectangular Drapery	<b>BP-254</b>	<b>B-254</b>	<b>HS-254</b>	<b>HB-254</b>	<b>TS-230</b>
<b>54-VLE</b>	53 x 18	Rectangular Drapery (Electric)	<b>N/A</b>	<b>N/A</b>	<b>HS-254</b>	<b>HB-254</b>	<b>TS-233</b>
<b>55-VA</b>	53 x 24	Rectangular	<b>BP-263</b>	<b>B-263</b>	<b>HS-263</b>	<b>HB-263</b>	<b>TS-234</b>
<b>55-VAE</b>	53 x 24	Rectangular (Electric)	<b>N/A</b>	<b>N/A</b>	<b>HS-263</b>	<b>HB-263</b>	<b>TS-235</b>
<b>391-SCS</b> <b>392-SCS</b> <b>393-SCS</b>	21 x 8 14 x 7	Collar Cuffs (2)	<b>BP-1331</b> <b>BP-1926**</b>	<b>B-1331</b> <b>B-1926**</b>	<b>HS-1331</b> <b>HS-1926**</b>	<b>HB-1331</b> <b>HB-1926</b>	<b>TS-1923</b> (Set of 3)
<b>391-SCSY</b> <b>392-SCSY</b>	21 x 7 14 x 7	Collar/Yoke Cuffs (2)	<b>BP-95</b> <b>BP-1926**</b>	<b>B-95</b> <b>B-1926**</b>	<b>HS-95</b> <b>HS-1926**</b>	<b>HB-95</b> <b>HB-1926</b>	<b>TS-1926</b> (Set of 3)
<b>392-VCH</b>	21 x 8 14 x 7	Collar/Yoke Cuffs (2)	<b>BP-105</b> <b>BP-1922</b>	<b>B-105</b> <b>B-1922</b>	<b>HS-105</b> <b>HS-1922</b>	<b>HB-105</b> <b>HB-1922</b>	<b>TS-1922</b> (Set of 3)
<b>392-VCHD</b>	21 x 8 12 x 7	Collar Cuffs (2)	<b>BP-1331</b> <b>BP-30*</b>	<b>B-1331</b> <b>B-30*</b>	<b>HS-1331</b> <b>HS-30*</b>	<b>HB-1331</b> <b>HB-30</b>	<b>TS-207</b> (Set of 3)
<b>392-VCHY</b>	21 x 7 12 x 7	Collar/Yoke Cuffs (2)	<b>BP-95</b> <b>BP-30*</b>	<b>B-95</b> <b>B-30*</b>	<b>HS-95</b> <b>HS-30*</b>	<b>HB-95</b> <b>HB-30</b>	<b>TS-209</b> (Set of 3)
<b>450-MIL</b>	22 x 21 x 11 - Left 22 x 21 x 11 - Right	Double Short Sleeve	<b>BP-703</b> <b>BP-499</b>	<b>B-703</b> <b>B-499</b>	<b>HS-703</b> <b>HS-499</b>	<b>HB-703</b> <b>HB-499</b>	<b>TS-236</b> (Set of 2)
<b>450- MILE</b>	22 x 21 x 11 - Left 22 x 21 x 11 - Right	Double Short Sleeve (Electric)	<b>N/A</b> <b>N/A</b>	<b>N/A</b> <b>N/A</b>	<b>HS-703</b> <b>HS-499</b>	<b>HB-703</b> <b>HB-499</b>	<b>TS-237</b> (Set of 2)
<b>450-MIL-L</b>	25½ x 23 x 10 - Left 25½ x 23 x 10 - Right	Double Short Sleeve	<b>BP-1336</b> <b>BP-1337</b>	<b>B-1336</b> <b>B-1337</b>	<b>HS-1336</b> <b>HS-1337</b>	<b>HB-1336</b> <b>HB-1337</b>	<b>TS-238</b> (Set of 2)
<b>3516</b>	36 x 12	Double End Pants Topper	<b>BP-184</b>	<b>B-184</b>	<b>HS-184</b>	<b>HB-184</b>	<b>TS-239</b>
<b>3516-VS</b>	36 x 12	Double End Pants Topper	<b>BP-184</b>	<b>B-184</b>	<b>HS-184</b>	<b>HB-184</b>	<b>TS-240</b>
<b>3516-VSNE</b>	36 x 12	Double End Pants Topper (Electric)	<b>N/A</b>	<b>N/A</b>	<b>HS-184</b>	<b>HB-184</b>	<b>TS-241</b>
<b>4224</b>	42 x 24	Rectangular	<b>BP-213</b>	<b>B-213</b>	<b>HS-213</b>	<b>HB-213</b>	<b>TS-242</b>
<b>4224-VAN</b>	42 x 24	Rectangular	<b>BP-213</b>	<b>B-213</b>	<b>HS-213</b>	<b>HB-213</b>	<b>TS-243</b>
<b>4224-VL</b>	42 x 24	Rectangular	<b>BP-213</b>	<b>B-213</b>	<b>HS-213</b>	<b>HB-213</b>	<b>TS-244</b>
<b>6024-VLFV</b> <b>6024-VLFP</b>	60 x 24	Rectangular	<b>BP-1978</b>	<b>B-1978</b>	<b>HS-1978</b>	<b>HB-1978</b>	<b>TS-1978</b>

\* Cuff Covers w/Front Guard **(30)**

Left Cuff: 1314 (Requires 1  
Right Cuff: 1315 of each)

\*\* Cuff Covers w/Front Guard **(1926)**

Left Cuff: 1953 (Requires 1  
Right Cuff: 1955 of each)



## FUJICAR

### AIR BAG BODY PRESS

MFG. MODEL NUMBER	BUCK SIZE	BUCK DESCRIPTION	COVERS		FLANNEL PADS	
			BON-DAC COVER W/ SIDE BAGS	BON-DAC COVER W/ PF BACK W/ SIDE BAGS	50 OZ. BONN-E- BLUE	80 OZ. BONN-E- BLUE
<b>FDB-001A</b> <b>FDB-002A</b>	20"	Double Body Vacuum	N/A	<b>APF-1654</b>	<b>HB-1654</b>	<b>SL-1654</b>
<b>FDB-105A</b>	18"	Double Body	<b>A-1196</b>	<b>APF-1196</b>	<b>HB-1196</b>	<b>SL-1196</b>
<b>FDB-110A</b>	18"	Double Body Vacuum	N/A	<b>APF-1653</b>	<b>HB-1653</b>	<b>SL-1653</b>
<b>FDB-201A</b>	18"	Single Body	<b>A-1196</b>	<b>APF-1196</b>	<b>HB-1196</b>	<b>SL-1196</b>

### SLEEVER UNITS

MFG. MODEL NUMBER	DESCRIPTION	PF COVER WITH SIDE BAGS	30 OZ. BONN-E-BLUE PAD
<b>FSP-551A</b>	Single Sleever (2)	<b>PF-1199</b>	<b>FB-1199</b>
<b>FSP-850A</b>	Double Sleever (4)	<b>PF-1199</b>	<b>FB-1199</b>

**FUJISTAR  
EQUIPMENT**

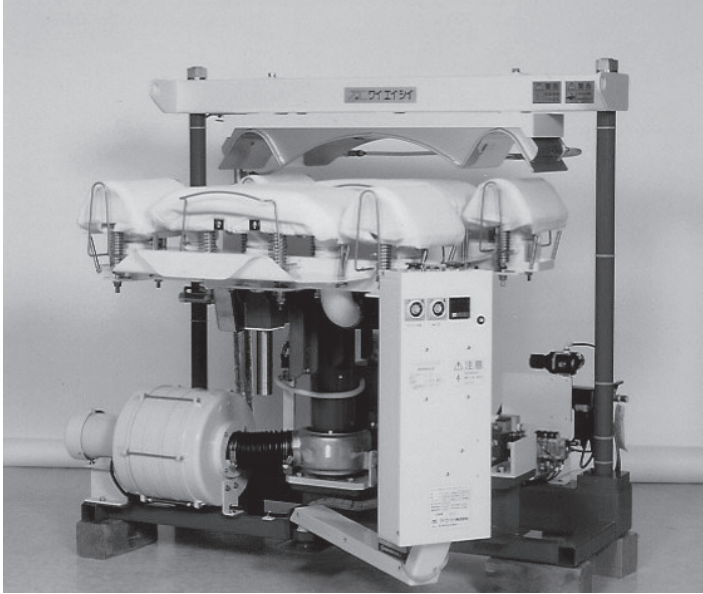

YPS-501-A



FDB-921

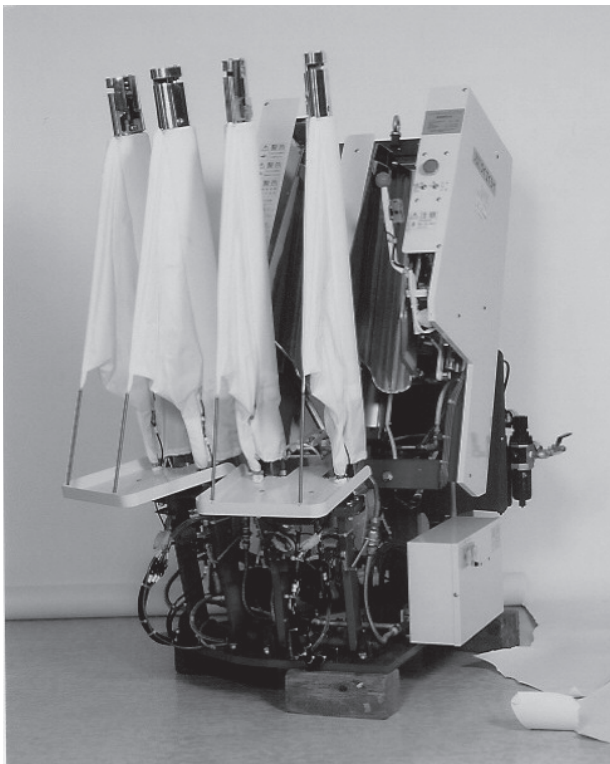

YPS-801-A  
FSP-911-A

# LAUNDRY



## FUJISTAR/Y.A.C. AIR BAG BODY PRESS

MFG. MODEL NUMBER	DESCRIPTION	WHITE ARAMID COVER W/AIR BAGS	50 OZ. BONN-E-BLUE PAD
<b>YPS-021E</b>	Double Buck	<b>WA-2235</b>	<b>HB-2235</b>
<b>YPS-121E</b>	Double Buck	<b>WA-2235</b>	<b>HB-2235</b>
<b>FBS-200</b>	Single Buck	<b>WA-1884</b>	<b>HB-1884</b>
<b>YPS-211E</b>	Single Buck	<b>WA-1884</b>	<b>HB-1884</b>
<b>FDB-921</b>	Double Buck	<b>WA-1884</b>	<b>HB-1884</b>

## FUJISTAR/Y.A.C. SINGLE BUCK BODY

MFG. MODEL NUMBER	WHITE ARAMID COVER	80 OZ. BUCK PAD	SIDE AIRBAGS	TUCK COVER/PADS	TAIL CLAMP COVER	TAIL CLAMP PAD
<b>YPS-301</b>	<b>WA-2350</b>	<b>SL-2350</b>	<b>N/A</b>	<b>Top: 2302 (2)</b> <b>Bottom: Left: 2304 Right: 2305</b> <b>Middle: Left: S-2296 Right: S-2298 Pads: M-2296 (2)</b>	<b>WA-2354</b>	<b>SL-2354</b>

\* Requires 2

## SLEEVER UNITS

MFG. MODEL NUMBER	DESCRIPTION	SLEEVER COVER	30 OZ. BONN-E-BLUE PAD	50 OZ. BONN-E-BLUE PAD
<b>FBS-101A</b>	Single Sleever (2)	<b>1540</b>	<b>FB-1541</b>	<b>HB-1541</b>
<b>YPS-411E</b>	Single Sleever (2)			
<b>YPS-801A</b>	Double Sleever (4)			
<b>YPS-811E</b>	Single Sleever (2)			
<b>YPS-812-E</b>	Double Sleever (4)			
<b>FSP-911A</b>	Double Sleever (4)			

## FUJICAR/FUJISTAR/Y.A.C. COLLAR AND CUFF UNITS

MFG. MODEL NUMBER	BUCK SIZE	DESCRIPTION	BON-SPUN NYLON COVER	50 OZ. BONN-E-BLUE PAD
<b>FTP-150</b>	22 1/2 x 10	Collar	<b>B-1301</b>	<b>HB-1301</b>
<b>FTP-154</b>	11 1/2 x 10	Cuffs (2)	<b>B-1300</b>	<b>HB-1300</b>
<b>FTP-550</b>	22 1/2 x 10	Collar(2)	<b>B-1301</b>	<b>HB-1301</b>
<b>FTP-553A</b>	11 1/2 x 10	Cuffs (4)	<b>B-1300</b>	<b>HB-1300</b>
MFG. MODEL NUMBER	BUCK SIZE	DESCRIPTION	WHITE ARAMID COVER	50 OZ. BONN-E-BLUE PAD
<b>YPS-501A</b>	22 1/2 x 10	Collar (2)	<b>WA-2033</b>	<b>HB-2033</b>
<b>YPS-501E</b>	11 1/2 x 10	Cuffs (4)	<b>WA-2034</b>	<b>HB-2034</b>
MFG. MODEL NUMBER	BUCK SIZE	DESCRIPTION	WHITE ARAMID COVER	80 OZ. BONN-E-BLUE PAD
<b>YPS-601</b>	22 x 10	Collar	<b>WA-2288</b>	<b>SL-2288</b>
	11 1/2 x 10	Cuffs (2)	<b>WA-2289</b>	<b>SL-2289</b>

# LAUNDRY



## GOBUKSON CABINET SHIRT PRESS

MFG. MODEL NUMBER	DESCRIPTION	WHITE KNIT COVER	50 OZ. BONN-E-BLUE PAD	AIR BAG	TUCK COVER/PAD	SILICONE BASE PAD
<b>GBS-101</b>	Single	<b>WK-1816</b>	<b>HB-1816</b>	<b>1818*</b>	<b>WKFB-1822*</b>	<b>RS-1816</b>

\*Requires 2

## FLATBED PRESSES

MFG. MODEL NUMBER	BUCK SIZE	DESCRIPTION	COMBO		COVERS		PADS
			BONPAK NYLON COVER/PAD	BON-SPUN NYLON	HI-SPUN ARAMID	50 OZ. BONN-E-BLUE	TEXSTEEL STEEL BASE PAD BARE BUCK
<b>KLH-18-DH</b>	36 x 12	Double Pants Topper	<b>BP-2244</b>	<b>B-2244</b>	<b>HS-2244</b>	<b>HB-2244</b>	<b>TS-2244</b>
<b>KL-52-H</b>	50 x 20 x 9½	Tapered	<b>BP-2250</b>	<b>B-2250</b>	<b>HS-2250</b>	<b>HB-2250</b>	<b>TS-2250</b>

MFG. MODEL NUMBER	DESCRIPTION	BON-SPUN COVER CLOTH 7½x 10 YD. ROLL	30 OZ. BONN-E-BLUE PADDING 7"x 10 YD. ROLL	12 OZ. JUPITER COVER 7" x 60" ROLL	SILICONE BASE PAD
<b>GBS-103</b>	Collar/Cuff	<b>RL-1</b>	<b>RL-44</b>	<b>RL-2325*</b>	<b>CS-2206</b> (set of 3)

\* To be cut and glued to buck prior to installation of Silicone. Glue available upon request.

## GOLDMAN FLATBED PRESSES

MFG. MODEL NUMBER	BUCK SIZE	DESCRIPTION	COMBO		COVERS		PADS
			BONPAK NYLON COVER/PAD	BON-SPUN NYLON	HI-SPUN ARAMID	50 OZ. BONN-E-BLUE	TEXSTEEL STEEL BASE PAD BARE BUCK
<b>GMH-19</b>	20½ x 10½	Mushroom	<b>BP-690</b>	<b>B-690</b>	<b>HS-690</b>	<b>HB-690</b>	<b>TS-175</b>
<b>GMH-32</b>	30 x 14 x 11½	Body Bosom	<b>BP-166</b>	<b>B-166</b>	<b>HS-166</b>	<b>HB-166</b>	<b>TS-166</b>
<b>GMH-54</b>	54 x 19 x 11½ 54 x 18	Tapered -OR- Rectangular	<b>BP-258</b> <b>BP-254</b>	<b>B-258</b> <b>B-254</b>	<b>HS-258</b> <b>HS-254</b>	<b>HB-258</b> <b>HB-254</b>	<b>TS-517</b> <b>TS-522</b>
<b>GMH-56</b>	53 x 19 x 12	Tapered	<b>BP-266</b>	<b>B-266</b>	<b>HS-266</b>	<b>HB-266</b>	<b>TS-519</b>

## HI-STEAM FLATBED PRESS

MFG. MODEL NUMBER	BUCK SIZE	DESCRIPTION	WHITE ARAMID COVER/PAD	SILICONE BASE PAD
<b>CB510</b>	25½ x 7½ 15 x 7½	Collar Cuff (2)	<b>WADB-2204</b> <b>WADB-2207</b>	<b>CS-2204</b> (Set of 3)



**HOFFMAN/NEW YORKER  
EQUIPMENT**

---

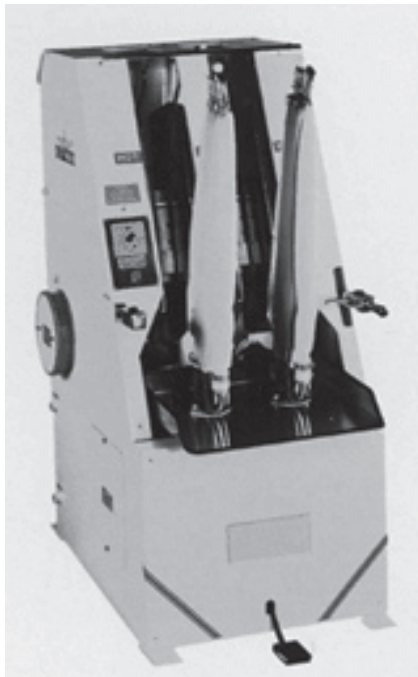

**CSL  
SLEEVER**



**DBC-V  
DOUBLE BUCK**

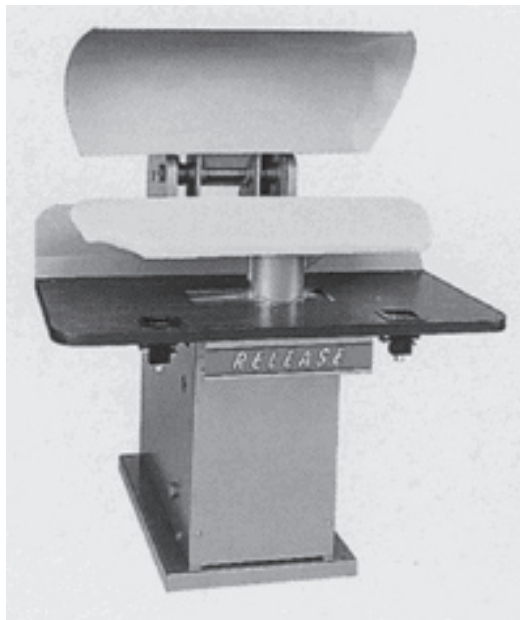

**ALB-6**



## HOFFMAN/NEW YORKER CABINET BOSOM PRESSES

MFG. MODEL NUMBER	BUCK DESCRIPTION	COVER		FLANNEL PADS			TEXSTEEL STEEL BASE PAD
		WHITE SIDES	50 OZ. PRYME	30 OZ. PRYME	50 OZ. BONN-E-BLUE	30 OZ. BONN-E-BLUE	
<b>SBC</b>	18" Single	<b>AW-570</b>	<b>H-570</b>	<b>F-570</b>	<b>HB-570</b>	<b>FB-570</b>	<b>TS-570</b>
<b>SBC-BV</b> <b>SBC-V</b>	18" Single Vacuum	<b>AW-570</b>	<b>H-570</b>	<b>F-570</b>	<b>HB-570</b>	<b>FB-570</b>	<b>TS-570V</b>
<b>DBC</b>	18" Double	<b>AW-570</b>	<b>H-570</b>	<b>F-570</b>	<b>HB-570</b>	<b>FB-570</b>	<b>TS-570</b>
<b>DBR-BV</b> <b>DBC-V</b>	18" Double Vacuum	<b>AW-570</b>	<b>H-570</b>	<b>F-570</b>	<b>HB-570</b>	<b>FB-570</b>	<b>TS-570V</b>
<b>SBC</b>	20" Single	<b>AW-574</b>	<b>H-574</b>	<b>F-574</b>	<b>HB-574</b>	<b>FB-574</b>	<b>TS-574</b>
<b>SBC-BV</b> <b>SBC-V</b>	20" Single Vacuum	<b>AW-574</b>	<b>H-574</b>	<b>F-574</b>	<b>HB-574</b>	<b>FB-574</b>	<b>TS-574V</b>
<b>DBC</b>	20" Double	<b>AW-574</b>	<b>H-574</b>	<b>F-574</b>	<b>HB-574</b>	<b>FB-574</b>	<b>TS-574</b>
<b>DBC-V</b> <b>DBR-BV</b>	20" Double Vacuum	<b>AW-574</b>	<b>H-574</b>	<b>F-574</b>	<b>HB-574</b>	<b>FB-574</b>	<b>TS-574V</b>

## CABINET SLEEVE PRESS

MFG. MODEL NUMBER	DESCRIPTION	COVERS		PAD			CLEAN BOOT
		PF W/ WHITE SIDES	PF W/ OVERSIZED WHITE SIDES	20 OZ. STOCKING BONN-E-BLUE PAD	TEXSTEEL STEEL BASE PAD (SET OF 2)	SPRING PAD ASSEMBLY (SET OF 4)	
<b>CSL</b>	Shirt	<b>PFW-154*</b>	<b>PFW-1789*</b>	<b>DB-153*</b>	<b>Set TS-154</b>	<b>SET SPA-154</b>	<b>M-801*</b>

\* Requires 2

- The 20 oz. slip-over stocking BONN-E-BLUE pad (**DB-153, DB-47, & DB-158**) is designed for use over worn steel base pads.
- TEXSTEEL steel base pads (**Set TS-154, Set TS-48, & Set TS-159**) are enclosed with heat resistant zip-on material for easy installation.

# LAUNDRY



## HOFFMAN/NEW YORKER FLATBED PRESSES

MFG. MODEL NUMBER	BUCK SIZE	DESCRIPTION	COMBO	COVERS		PADS	
			BONPAK NYLON COVER/ PAD	BON-SPUN NYLON	HI-SPUN ARAMID	50 OZ. BONN-E- BLUE	TEXSTEEL STEEL BASE PAD*
<b>ALB-1</b>	40 x 18	Body Bosom	<b>BP-208</b>	<b>B-208</b>	<b>HS-208</b>	<b>HB-208</b>	<b>TS-245</b>
<b>ALCA-1</b>	52 x 17	Rectangular	<b>BP-247</b>	<b>B-247</b>	<b>HS-247</b>	<b>HB-247</b>	<b>TS-246</b>
<b>ALM-1</b>	18 x 8	Oval Mushroom	<b>BP-44</b>	<b>B-44</b>	<b>HS-44</b>	<b>HB-44</b>	<b>TS-247</b>
<b>ALY-1</b>	21 x 12	Yoke	<b>BP-94</b>	<b>B-94</b>	<b>HS-94</b>	<b>HB-94</b>	<b>TS-248</b>
<b>ALM-3S</b>	21 x 10	Oval Mushroom	<b>BP-67</b>	<b>B-67</b>	<b>HS-67</b>	<b>HB-67</b>	<b>TS-249</b>
<b>ALM-3E</b>	21 x 10	Oval Mushroom (Electric)	<b>N/A</b>	<b>N/A</b>	<b>HS-67</b>	<b>HB-67</b>	<b>TS-250</b>
<b>ALY-5</b>	16½ x 10	Yoke w/Cut-Out	<b>BP-34</b>	<b>B-34</b>	<b>HS-34</b>	<b>HB-34</b>	<b>TS-251</b>
<b>ALB-6</b>	39 x 18	Body Bosom	<b>BP-1165</b>	<b>B-1165</b>	<b>HS-1165</b>	<b>HB-1165</b>	<b>TS-252</b>
<b>ALS-6</b>	22 x 10 Left 22 x 10 Right	Double Sleever	<b>BP-467</b> <b>BP-610</b>	<b>B-467</b> <b>B-610</b>	<b>HS-467</b> <b>HS-610</b>	<b>HB-467</b> <b>HB-610</b>	<b>TS-253</b> (Set of 2)
<b>ALY-6</b>	22 x 11	Yoke w/Cut-Out	<b>BP-87</b>	<b>B-87</b>	<b>HS-87</b>	<b>HB-87</b>	<b>TS-254</b>
<b>ALL-7</b>	42 x 24	Double Legger	<b>BP-213</b>	<b>B-213</b>	<b>HS-213</b>	<b>HB-213</b>	<b>TS-255</b>
<b>ALB-8</b>	35 x 18	Body Bosom w/Slit	<b>BP-198</b>	<b>B-198</b>	<b>HS-198</b>	<b>HB-198</b>	<b>TS-256</b>
<b>ALC-8</b>	20 x 7 13 x 7	Collar Cuffs (2)	<b>BP-1147</b> <b>BP-1145</b>	<b>B-1147</b> <b>B-1145</b>	<b>HS-1147</b> <b>HS-1145</b>	<b>HB-1147</b> <b>HB-1145</b>	<b>TS-257</b> (Set of 3)
<b>ALCY-8</b>	20½ x 8¾ 14½ x 6½	Collar/Yoke Cuffs (2)	<b>BP-1143</b> <b>BP-1307</b>	<b>B-1143</b> <b>B-1307</b>	<b>HS-1143</b> <b>HS-1307</b>	<b>HB-1143</b> <b>HB-1307</b>	<b>TS-258</b> (Set of 3)
<b>ALB-10-E</b>	30 x 16 x 10	Body Bosom (Electric)	<b>N/A</b>	<b>N/A</b>	<b>HS-613</b>	<b>HB-613</b>	<b>TS-259</b>
<b>ALCY-10-E</b>	20½ x 8¾ 13½ x 6½	Yoke Cuff (Electric)	<b>N/A</b> <b>N/A</b>	<b>N/A</b> <b>N/A</b>	<b>HS-611</b> <b>HS-32</b>	<b>HB-611</b> <b>HB-32</b>	<b>TS-260</b> (Set of 2)
<b>ALS11E</b>	7 x 4	Gusset Sleever (4) (Electric)	<b>HTD-15</b> HI-SPUN Cover w/DFN Pad				<b>TS-261</b> (Set of 4)
<b>ALS11S</b> <b>ALS12S</b>	7 x 4	Gusset Sleever (4)	<b>HTD-15</b> HI-SPUN Cover w/DFN Pad Air Retention Boots <b>M-743</b> (2 required)				<b>TS-262</b> (Set of 4)
<b>ALT-12</b>	35 x 11	Double End Pants Topper	<b>BP-184</b>	<b>B-184</b>	<b>HS-184</b>	<b>HB-184</b>	<b>TS-263</b>
<b>LBCY-12</b>	20½ x 8¾ 14½ x 6½	Bobcat Collar/Yoke Cuff	<b>BP-1143</b> <b>BP-1307</b>	<b>B-1143</b> <b>B-1307</b>	<b>HS-1143</b> <b>HS-1307</b>	<b>HB-1143</b> <b>HB-1307</b>	<b>TS-264</b> (Set of 2)

\* SPECIFY BARE BUCK  
or OVERSPRINGS

# LAUNDRY



## HOFFMAN/NEW YORKER FLATBED PRESSES

MFG. MODEL NUMBER	BUCK SIZE	DESCRIPTION	COMBO	COVERS		PADS	TEXSTEEL STEEL BASE PAD*
			BONPAK NYLON COVER/ PAD	BON-SPUN NYLON	HI-SPUN ARAMID	50 OZ. BONNE- BLUE	
<b>LB-14</b>	30 x 14 x 11	Bobcat Body Bosom	<b>BP-166</b>	<b>B-166</b>	<b>HS-166</b>	<b>HB-166</b>	<b>TS-265</b>
<b>ALM-19</b>	18 x 8 <sup>1</sup> / <sub>4</sub>	Mushroom	<b>BP-44</b>	<b>B-44</b>	<b>HS-44</b>	<b>HB-44</b>	<b>TS-577</b>
<b>ALM-21</b>	21 <sup>1</sup> / <sub>2</sub> x 10	Mushroom	<b>BP-67</b>	<b>B-67</b>	<b>HS-67</b>	<b>HB-67</b>	<b>TS-267</b>
<b>AL-38</b> <b>ALU-38</b>	38 x 12 x 9	Utility	<b>BP-196</b>	<b>B-196</b>	<b>HS-196</b>	<b>HB-196</b>	<b>TS-266</b>
<b>AL42</b> <b>ALU-42</b>	42 x 12 x 9	Utility	<b>BP-212</b>	<b>B-212</b>	<b>HS-212</b>	<b>HB-212</b>	<b>TS-576</b>
<b>AL-45</b>	45 x 12 x 9	Utility	<b>BP-222</b>	<b>B-222</b>	<b>HS-222</b>	<b>HB-222</b>	<b>TS-268</b>
<b>ALU-51</b>	51 x 18 <sup>1</sup> / <sub>2</sub> x 9	Tapered	<b>BP-234</b>	<b>B-234</b>	<b>HS-234</b>	<b>HB-234</b>	<b>TS-269</b>
<b>ALU-52-E</b>	52 x 16 <sup>1</sup> / <sub>2</sub> x 9	Tapered (Electric)	<b>N/A</b>	<b>N/A</b>	<b>HS-238</b>	<b>HB-238</b>	<b>TS-270</b>
<b>ALU-53</b>	53 x 18 x 13	Tapered	<b>BP-266</b>	<b>B-266</b>	<b>HS-266</b>	<b>HB-266</b>	<b>TS-271</b>
<b>ALB-54</b>	60 x 18 <sup>1</sup> / <sub>2</sub> x 14 <sup>1</sup> / <sub>2</sub>	Tapered	<b>BP-554</b>	<b>B-554</b>	<b>HS-554</b>	<b>HB-554</b>	<b>TS-554</b>
<b>ALU-56</b>	56 x 20 x 12	Tapered	<b>BP-716</b>	<b>B-716</b>	<b>HS-716</b>	<b>HB-716</b>	<b>TS-272</b>
<b>AL20x40</b>	40 x 20	Flat Hot Head	<b>BP-208</b>	<b>B-208</b>	<b>HS-208</b>	<b>HB-208</b>	<b>TS-273</b>
<b>AL24x48</b>	48 x 24	Flat Hot Head	<b>BP-229</b>	<b>B-229</b>	<b>HS-229</b>	<b>HB-229</b>	<b>TS-274</b>
<b>AL24x60</b>	60 x 24	Flat Hot Head	<b>BP-278</b>	<b>B-278</b>	<b>HS-278</b>	<b>HB-278</b>	<b>TS-275</b>
<b>AL28x80</b>	80 x 28	Flat Hot Head	<b>BP-396</b>	<b>B-396</b>	<b>HS-396</b>	<b>HB-396</b>	<b>TS-276</b>
<b>AL30x60</b>	60 x 30	Flat Hot Head	<b>BP-279</b>	<b>B-279</b>	<b>HS-279</b>	<b>HB-279</b>	<b>TS-277</b>
<b>AL30x72</b>	72 x 30	Flat Hot Head	<b>BP-363</b>	<b>B-363</b>	<b>HS-363</b>	<b>HB-363</b>	<b>TS-278</b>
<b>DO-7</b>	29 x 96	Flat Hot Head	<b>BP-2178</b>	<b>B-2178</b>	<b>HS-2178</b>	<b>HB-2178</b>	<b>TS-2178</b>
<b>CO-8</b> <b>DO-8</b>	29 x 110	Flat Hot Head	<b>BP-427</b>	<b>B-427</b>	<b>HS-427</b>	<b>HB-427</b>	<b>TS-117</b>

BP - BON-TWILL COVER  
WITH 50 OZ. PAD



\* SPECIFY BARE BUCK  
or OVER SPRINGS

# LAUNDRY



## HOFFMAN/NEW YORKER HOT AIR SHIRT FINISHER

MFG. MODEL NUMBER	FORM COVER	HI-SPUN CLAMP COVER	21 OZ. PRYME DFN FLANNEL CLAMP PAD
<b>3590 DAISY</b>	<b>PF-1316</b>	<b>HS-1208</b>	<b>D-1208</b>
<b>3591 DAISY</b>	<b>PF-1283</b>	<b>HS-1208</b>	<b>D-1208</b>

## ITSUMI SHIRT FINISHER

MFG. MODEL NUMBER	WHITE KNIT COVER	50 OZ. BONN-E-BLUE PAD	AIR BAG	TUCK COVER/PAD	SHORT SLEEVE CLAMP COVER	SILICONE BASE PAD
<b>BTIXMC99 (Single)</b> <b>DB-500A (Double)</b>	<b>WK-1816</b>	<b>HB-1816</b>	<b>1818*</b>	<b>WKFB-1822 *</b>	<b>1856**</b>	<b>RS-1816</b>
<b>BT-100 (Single)</b> <b>BT-500 (Double)</b>	<b>WK-2166</b>	<b>HB-2166</b>	<b>2170*</b>	<b>WKFB-2168*</b>	<b>N/A</b>	<b>RS-2166</b>

\* Requires 2  
\*\* Requires 4

## ITSUMI FLATBED PRESSES

MFG. MODEL NUMBER	DESCRIPTION	BON-SPUN COVER CLOTH 7½x 10 YD. ROLL	30 OZ. BONN-E-BLUE PADDING 7"x 10 YD. ROLL	SILICONE BASE PAD
<b>MXP-1</b>	Collar/Cuff	<b>RL-1</b>	<b>RL-44</b>	<b>CS-2206</b> (set of 3)

\*\*\* To be cut and glued to buck prior to installation of Silicone. Glue available upon request.

MFG. MODEL NUMBER	DESCRIPTION	CONTINUOUS COLLAR/CUFF COVER	COLLAR PAD	CUFF PAD
<b>DC500 (Double)</b>	Collar (2) Cuff (4)	<b>HS-2632</b>	<b>HB-2632</b>	<b>HB-2634</b>

MFG. MODEL NUMBER	BUCK SIZE	DESCRIPTION	BONPAK NYLON COVER/PAD	BON-SPUN NYLON	HI-SPUN ARAMID	50 OZ. BONN-E-BLUE	TEXSTEEL STEEL BASE PAD BARE BUCK
<b>SC711T</b>	43½X20	<b>Rectangular</b>	<b>BP-2636</b>	<b>B-2636</b>	<b>HB-2636</b>	<b>HB-2636</b>	<b>TS-2636</b>

# LAUNDRY



## KUMSUNG

### CABINET SHIRT PRESSES

MFG. MODEL NUMBER	WHITE KNIT COVER	BON SPUN COVER	AIR BAG	TUCK COVER/PAD	SHORT SLEEVE CLAMP COVER	SILICONE BASE PAD
<b>PRO-S101 SIGNET PLUS</b>	<b>WK-1816</b>	<b>B-1816</b>			<b>1856**</b>	<b>RS-1816</b>

\* Requires 2  
\*\* Requires 4

## KUMSUNG

### FLATBED PRESSES

MFG. MODEL NUMBER	DESCRIPTION	BON-SPUN COVER CLOTH 7½x 10 YD. ROLL	30 OZ. BONN-E-BLUE PADDING 7"x 10 YD. ROLL		SILICONE BASE PAD
<b>LC-103</b>	Collar/Cuff	<b>RL-1</b>	<b>RL-44</b>		<b>CS-2206 (set of 3)</b>

\*\*\* To be cut and glued to buck prior to installation of Silicone. Glue available upon request.

## MACPI/MIRACLEAN

### SLEEVER UNIT

MFG. MODEL NUMBER	DESCRIPTION	HI-SPUN W/ DFN (GUSSET) COVER/PAD
<b>9111</b>	Post Sleever	<b>HTD-6*</b>

\* Requires 2

### HOT AIR SHIRT FINISHER

MFG. MODEL NUMBER	FORM COVER
<b>SPEEDY</b>	<b>PF-1334</b>

## McCALLISTER

### SINGLE BUCK SHIRT PRESS

MFG. MODEL NUMBER	WHITE ARAMID BUCK COVER	50 OZ. BUCK PAD	30 OZ. BUCK PAD	TUCK COVER AND FOAM PAD	SHORT SLEEVE COVER	COLLAR CLAMP COVER
<b>MRS-100-S</b>	<b>WA-2104</b>	<b>HB-1722</b>	<b>FB-1722</b>	<b>S-1723* FM-1723*</b>	<b>1725*</b>	<b>1293</b>

\* Requires 2

## McCALLISTER

### FLATBED PRESSES

MFG. MODEL NUMBER	BUCK SIZE	DESCRIPTION	COMBO		COVERS		PADS	
			BONPAK NYLON COVER/PAD	BON-SPUN NYLON	HI-SPUN ARAMID	50 OZ. BONN-E-BLUE	TEXSTEEL STEEL BASE PAD BARE BUCK	
<b>MRS-108AH</b>	51 x 21 x 15	Utility	<b>BP-702</b>	<b>B-702</b>	<b>HS-702</b>	<b>HB-702</b>	<b>TS-702</b>	

### LA 46

CALL OR EMAIL US WITH ANY QUESTIONS  
937-462-5148 CUSTOMERSERVICE@FHBONN.COM

# LAUNDRY



## MITSUBISHI/MIYATA DRESS SHIRT BODY PRESS

MFG. MODEL NUMBER	DESCRIPTION	COVER	PAD	TUCK COVER AND PADS
<b>MB-120</b> <b>MB-50S</b>	Double Single	<b>AW-2135</b>	<b>FB-2135</b>	<b>WK-2138*</b> <b>FM-2138*</b> <b>DB-2138*</b>

\* Requires 2

## MITSUBISHI/MIYATA FLAT PRESSES

MFG. MODEL NUMBER	BUCK SIZE	DESCRIPTION	WHITE ARAMID COVER	20 OZ. BONN-E-BLUE PAD
<b>MRC-22S</b> <b>TWO TIER</b>	26 x 9½ 13½ x 9½	Collar Cuff (2)	<b>WA-2134</b> <b>WA-2136</b>	<b>DB-2139</b> <b>DB-2148</b>

## OTHIS SINGLE BUCK SHIRT PRESS

MFG. MODEL NUMBER	WHITE ARAMID BUCK COVER	BUCK PADS (REQUIRES 1 EACH)	TUCK COVER & PADS	ARAMID TAIL CLAMP COVER/PAD	COLLAR CLAMP COVER	SILICONE BASE PAD
<b>SM-711-U</b>	<b>WA-2098</b>	<b>FB-1722 (1)</b> (30 OZ.) <b>HB-1722 (1)</b> (50 OZ.)	<b>Left S-1893</b> <b>Right S-1894</b> <b>DB-1780*</b> <b>FM-1780*</b>	<b>N/A</b>	<b>1293</b>	<b>RS-1722</b>
<b>SM-722-U</b>	<b>WA-2554</b>			<b>2557</b>		

\* Requires 2

## FLATBED PRESSES

MFG. MODEL NUMBER	BUCK SIZE	DESCRIPTION	WHITE ARAMID COVER	30 OZ. PAD
<b>COLLAR/CUFF</b>	5 x 21 4 x 13	Collar Cuff (2)	<b>WA-2014</b> <b>WA-2017</b>	<b>FB-2014</b> <b>FB-2017</b>

# LAUNDRY



## PANTEX FLATBED PRESSES

MFG. MODEL NUMBER	BUCK SIZE	DESCRIPTION	COMBO	COVERS		PADS	TEXSTEEL STEEL BASE PAD*
			BONPAK NYLON COVER/ PAD	BON-SPUN NYLON	HI-SPUN ARAMID	50 OZ. BONN-E- BLUE	
<b>L-19</b>	18 x 9 <sup>1</sup> / <sub>2</sub>	Oval Mushroom	<b>BP-44</b>	<b>B-44</b>	<b>HS-44</b>	<b>HB-44</b>	<b>TS-279</b>
<b>L-20</b>	18 <sup>1</sup> / <sub>2</sub> x 13	Yoke	<b>BP-49</b>	<b>B-49</b>	<b>HS-49</b>	<b>HB-49</b>	<b>TS-280</b>
<b>L-22</b>	19 x 13	Yoke	<b>BP-49</b>	<b>B-49</b>	<b>HS-49</b>	<b>HB-49</b>	<b>TS-281</b>
<b>L-45</b>	45 x 13 x 9	Tapered	<b>BP-222</b>	<b>B-222</b>	<b>HS-222</b>	<b>HB-222</b>	<b>TS-282</b>
<b>L-51</b>	50 x 16 x 8	Tapered	<b>BP-233</b>	<b>B-233</b>	<b>HS-233</b>	<b>HB-233</b>	<b>TS-283</b>
<b>L-52</b>	51 x 16 x 10	Tapered	<b>BP-233</b>	<b>B-233</b>	<b>HS-233</b>	<b>HB-233</b>	<b>TS-284</b>
<b>L-53</b>	52 <sup>1</sup> / <sub>2</sub> x 18 x 9 <sup>1</sup> / <sub>2</sub>	Tapered	<b>BP-245</b>	<b>B-245</b>	<b>HS-245</b>	<b>HB-245</b>	<b>TS-285</b>
<b>L-60</b>	58 x 22 <sup>1</sup> / <sub>4</sub>	Rectangular	<b>BP-275</b>	<b>B-275</b>	<b>HS-275</b>	<b>HB-275</b>	<b>TS-286</b>
<b>L-119</b>	18 x 9 <sup>1</sup> / <sub>2</sub>	Oval Mushroom	<b>BP-44</b>	<b>B-44</b>	<b>HS-44</b>	<b>HB-44</b>	<b>TS-287</b>
<b>L-120</b>	18 <sup>1</sup> / <sub>2</sub> x 10 <sup>1</sup> / <sub>2</sub>	Yoke	<b>BP-49</b>	<b>B-49</b>	<b>HS-49</b>	<b>HB-49</b>	<b>TS-289</b>
<b>L-131-OPS</b>	30 x 14 <sup>1</sup> / <sub>2</sub> x 11	Body Bosom	<b>BP-166</b>	<b>B-166</b>	<b>HS-166</b>	<b>HB-166</b>	<b>TS-290</b>
<b>L-131-OPE</b>	30 x 14 <sup>1</sup> / <sub>2</sub> x 11	Body Bosom (Electric)	<b>N/A</b>	<b>N/A</b>	<b>HS-166</b>	<b>HB-166</b>	<b>TS-291</b>
<b>L-136</b>	36 x 12 <sup>1</sup> / <sub>4</sub>	Double End Pants Topper	<b>BP-184</b>	<b>B-184</b>	<b>HS-184</b>	<b>HB-184</b>	<b>TS-292</b>
<b>L-145</b>	44 x 12 x 8	Tapered	<b>BP-222</b>	<b>B-222</b>	<b>HS-222</b>	<b>HB-222</b>	<b>TS-293</b>
<b>L-151</b>	51 x 16 <sup>1</sup> / <sub>2</sub> x 8	Tapered	<b>BP-233</b>	<b>B-233</b>	<b>HS-233</b>	<b>HB-233</b>	<b>TS-294</b>
<b>L-153</b>	52 x 18 x 10	Tapered	<b>BP-245</b>	<b>B-245</b>	<b>HS-245</b>	<b>HB-245</b>	<b>TS-295</b>
<b>L-154</b>	52 <sup>1</sup> / <sub>2</sub> x 16 <sup>1</sup> / <sub>2</sub>	Rectangular	<b>BP-239</b>	<b>B-239</b>	<b>HS-239</b>	<b>HB-239</b>	<b>TS-296</b>
<b>L-157</b>	22 <sup>1</sup> / <sub>2</sub> x 10 <sup>1</sup> / <sub>2</sub> - Left 22 <sup>1</sup> / <sub>2</sub> x 10 <sup>1</sup> / <sub>2</sub> - Right	Double Sleever	<b>BP-467</b> <b>BP-610</b>	<b>B-467</b> <b>B-610</b>	<b>HS-467</b> <b>HS-610</b>	<b>HB-467</b> <b>HB-610</b>	<b>TS-297</b> (Set of 2)

\* SPECIFY BARE BUCK  
OR OVER SPRINGS

# LAUNDRY



## PANTEX FLATBED PRESSES

MFG. MODEL NUMBER	BUCK SIZE	DESCRIPTION	COMBO	COVERS		PADS	TEXSTEEL STEEL BASE PAD*
			BONPAK NYLON COVER/ PAD	BON-SPUN NYLON	HI-SPUN ARAMID	50 OZ. BONN-E- BLUE	
<b>K-160</b>	60 x 25 <sup>1</sup> / <sub>2</sub>	Rectangular	<b>BP-278</b>	<b>B-278</b>	<b>HS-278</b>	<b>HB-278</b>	<b>TS-298</b>
<b>L-160</b>	58 <sup>1</sup> / <sub>2</sub> x 22 <sup>1</sup> / <sub>2</sub>	Rectangular	<b>BP-275</b>	<b>B-275</b>	<b>HS-275</b>	<b>HB-275</b>	<b>TS-299</b>
<b>L-411</b>	40 <sup>1</sup> / <sub>2</sub> x 19 <sup>1</sup> / <sub>2</sub>	Body Bosom	<b>BP-210</b>	<b>B-210</b>	<b>HS-210</b>	<b>HB-210</b>	<b>TS-300</b>
<b>L-425</b>	41 x 17 <sup>3</sup> / <sub>4</sub>	Body Bosom	<b>BP-208</b>	<b>B-208</b>	<b>HS-208</b>	<b>HB-208</b>	<b>TS-301</b>
<b>L-453</b>	23 x 7 13 x 7	Collar Cuffs (2)	<b>BP-105</b> <b>BP-20</b>	<b>B-105</b> <b>B-20</b>	<b>HS-105</b> <b>HS-20</b>	<b>HB-105</b> <b>HB-20</b>	<b>TS-302</b> (Set of 3)
<b>L-1193</b>	19 <sup>1</sup> / <sub>2</sub> x 10 <sup>1</sup> / <sub>2</sub>	Oval Mushroom	<b>BP-51</b>	<b>B-51</b>	<b>HS-51</b>	<b>HB-51</b>	<b>TS-303</b>
<b>L-1210</b>	21 x 10 <sup>1</sup> / <sub>2</sub>	Yoke w/Cut-Out	<b>BP-87</b>	<b>B-87</b>	<b>HS-87</b>	<b>HB-87</b>	<b>TS-304</b>
<b>L-1215</b>	20 x 11	Oval Mushroom	<b>BP-102</b>	<b>B-102</b>	<b>HS-102</b>	<b>HB-102</b>	<b>TS-305</b>
<b>L-1223</b>	12 x 6	Cuffs (2)	<b>BP-20</b>	<b>B-20</b>	<b>HS-20</b>	<b>HB-20</b>	<b>TS-306</b> (Set of 2)
<b>L-1227</b>	23 x 6	Collar	<b>BP-105</b>	<b>B-105</b>	<b>HS-105</b>	<b>HB-105</b>	<b>TS-307</b>
<b>L-1400</b>	40 <sup>1</sup> / <sub>4</sub> x 20 <sup>1</sup> / <sub>4</sub>	Body Bosom	<b>BP-204</b>	<b>B-204</b>	<b>HS-204</b>	<b>HB-204</b>	<b>TS-308</b>
<b>L-1401</b>	40 <sup>1</sup> / <sub>4</sub> x 17 <sup>3</sup> / <sub>4</sub>	Body Bosom	<b>BP-210</b>	<b>B-210</b>	<b>HS-210</b>	<b>HB-210</b>	<b>TS-309</b>
<b>L-1410</b>	41 x 18	Body Bosom	<b>BP-208</b>	<b>B-208</b>	<b>HS-208</b>	<b>HB-208</b>	<b>TS-310</b>
<b>L-1411</b>	40 x 20	Body Bosom	<b>BP-210</b>	<b>B-210</b>	<b>HS-210</b>	<b>HB-210</b>	<b>TS-311</b>
<b>L-1455-PE</b>	20 <sup>1</sup> / <sub>2</sub> x 9 12 x 6	Collar Cuffs (2) (Electric)	<b>N/A</b> <b>N/A</b>	<b>N/A</b> <b>N/A</b>	<b>HS-115</b> <b>HS-20</b>	<b>HB-115</b> <b>HB-20</b>	<b>TS-314</b> (Set of 3)
<b>L-1455-PS</b>	20 <sup>1</sup> / <sub>2</sub> x 9 12 x 6	Collar Cuffs (2)	<b>BP-115</b> <b>BP-20</b>	<b>B-115</b> <b>B-20</b>	<b>HS-115</b> <b>HS-20</b>	<b>HB-115</b> <b>HB-20</b>	<b>TS-312</b> (Set of 3)
<b>L-1505</b>	49 x 19 <sup>1</sup> / <sub>2</sub> x 9	Tapered	<b>BP-230</b>	<b>B-230</b>	<b>HS-230</b>	<b>HB-230</b>	<b>TS-315</b>
<b>L-1515</b>	20 <sup>1</sup> / <sub>2</sub> x 10 <sup>1</sup> / <sub>2</sub> - Left 20 <sup>1</sup> / <sub>2</sub> x 10 <sup>1</sup> / <sub>2</sub> - Right	Double Sleever	<b>BP-91</b> <b>BP-92</b>	<b>B-91</b> <b>B-92</b>	<b>HS-91</b> <b>HS-92</b>	<b>HB-91</b> <b>HB-92</b>	<b>TS-316</b> (Set of 2)
<b>L-1555</b>	54 x 25	Rectangular	<b>BP-263</b>	<b>B-263</b>	<b>HS-263</b>	<b>HB-263</b>	<b>TS-317</b>

\* SPECIFY BARE BUCK  
or OVER SPRINGS

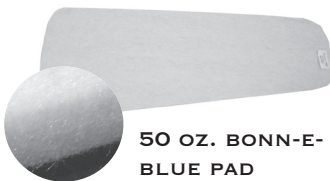

50 OZ. BONN-E-  
BLUE PAD

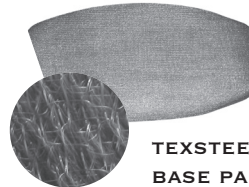

TEXSTEEL STEEL  
BASE PAD

# LAUNDRY



## PONY COLLAR & CUFF

MFG. MODEL NUMBER	BUCK SIZE	DESCRIPTION	WHITE ARAMID COVER/PAD
CCP	5 x 22 5 x 14	Collar Cuffs (2)	WADB-2494 WADB-2493

## PROSPERITY CABINET BOSOM PRESSES

MFG. MODEL NUMBER	COVERS		PADS		TEXSTEEL STEEL BASE PAD
	BON-SPUN NYLON	HI-SPUN ARAMID	50 OZ. BONN-E-BLUE	30 OZ. PRYME	
CBY20"	B-409	HS-409	HB-409	F-409	TS-409
DCBY18"	B-411	HS-411	HB-411	F-411	TS-411
3232-CBP	B-378	HS-378	HB-378	F-378	TS-378
3232-CBPY	B-383	HS-383	HB-383	F-383	TS-383

### EXPANDERS FOR ABOVE PRESSES (SEE DIAGRAMS BELOW)

MFG. MODEL NUMBER	COVER	PAD
CBY	M-407*	FB-407*
DCBY	M-408*	FB-408*
3232-CBP (Center Hinge)	M-375*	FB-375*
3232-CBP (High Hinge)	M-376*	FB-376*
3232-CBPY	M-376*	FB-376*

\* Requires 2

### EXPANDERS FOR ABOVE PRESSES

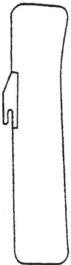

3232-CBP  
3232-CBPY  
HIGH HINGE  
#376



DCBY  
#408



3232-CBP  
CENTER HINGE  
#375

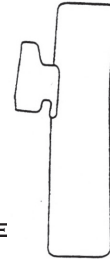

CBY  
#407



## PROSPERITY CABINET SLEEVES

### EXPANDERS

MFG. MODEL NUMBER	DESCRIPTION	POLYESTER COVER W/ 30 OZ. DFN PAD	PF COVER W/ 21 OZ. DFN PLUS BUILD-UP	TEXSTEEL STEEL BASE PAD	COVER*	PAD*
2121-CSP	Slip-On Type	CPFB-466*	T-466*	Set TS-634	M-99	DB-99
2121-CSP-II	Slip-On Type	CPFB-466*	T-466*	Set TS-107	M-99 or M-100	DB-99 or DB-100

\* Requires 2

### EXPANDERS FOR ABOVE PRESSES

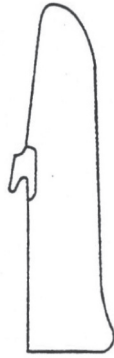

2121-CSP  
2121-CSP-II  
#99

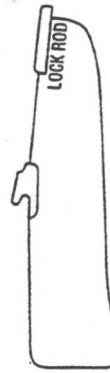

2121-CSP-II  
#100

# LAUNDRY



## PROSPERITY FLATBED PRESSES

MFG. MODEL NUMBER	BUCK SIZE	DESCRIPTION	COMBO	COVERS		PADS	TEXSTEEL STEEL BASE PAD*
			BONPAK NYLON COVER/ PAD	BON-SPUN NYLON	HI-SPUN ARAMID	50 OZ. BONNE- BLUE	
<b>L-38</b>	38 x 12 x 8	Tapered	<b>BP-200</b>	<b>B-200</b>	<b>HS-200</b>	<b>HB-200</b>	<b>TS-318</b>
<b>LCM-38</b>	39 x 12 x 7	Tapered	<b>BP-200</b>	<b>B-200</b>	<b>HS-200</b>	<b>HB-200</b>	<b>TS-319</b>
<b>LCP-38</b>	39 x 12 x 7	Tapered	<b>BP-200</b>	<b>B-200</b>	<b>HS-200</b>	<b>HB-200</b>	<b>TS-320</b>
<b>ALCP-40</b>	40 x 17½	Body Bosom	<b>BP-208</b>	<b>B-208</b>	<b>HS-208</b>	<b>HB-208</b>	<b>TS-321</b>
<b>CLCP-40</b>	40 x 18	Body Bosom	<b>BP-208</b>	<b>B-208</b>	<b>HS-208</b>	<b>HB-208</b>	<b>TS-322</b>
<b>LD-41</b>	39 x 12 x 7	Tapered	<b>BP-200</b>	<b>B-200</b>	<b>HS-200</b>	<b>HB-200</b>	<b>TS-323</b>
<b>L-51</b>	51 x 19 x 9	Tapered	<b>BP-234</b>	<b>B-234</b>	<b>HS-234</b>	<b>HB-234</b>	<b>TS-325</b>
<b>ALM-52</b>	52 x 17	Rectangular	<b>BP-239</b>	<b>B-239</b>	<b>HS-239</b>	<b>HB-239</b>	<b>TS-326</b>
<b>ALP-52</b>	52 x 17	Rectangular	<b>BP-239</b>	<b>B-239</b>	<b>HS-239</b>	<b>HB-239</b>	<b>TS-327</b>
<b>118</b>	17½ x 8	Oval Mushroom	<b>BP-44</b>	<b>B-44</b>	<b>HS-44</b>	<b>HB-44</b>	<b>TS-328</b>
<b>124-P</b>	19¼ x 9	Collar	<b>BP-72</b>	<b>B-72</b>	<b>HS-72</b>	<b>HB-72</b>	<b>TS-329</b>
<b>132</b>	32 x 20	Body Bosom	<b>BP-172</b>	<b>B-172</b>	<b>HS-172</b>	<b>HB-172</b>	<b>TS-330</b>
<b>133</b>	32 x 15 x 12	Coverall	<b>BP-176</b>	<b>B-176</b>	<b>HS-176</b>	<b>HB-176</b>	<b>TS-332</b>
<b>146-P</b>	46½ x 18½	Rectangular	<b>BP-226</b>	<b>B-226</b>	<b>HS-226</b>	<b>HB-226</b>	<b>TS-549</b>
<b>154</b>	54 x 18½	Rectangular	<b>BP-254</b>	<b>B-254</b>	<b>HS-254</b>	<b>HB-254</b>	<b>TS-333</b>
<b>160</b>	60 x 24	Flatwork Rectangular	<b>BP-278</b>	<b>B-278</b>	<b>HS-278</b>	<b>HB-278</b>	<b>TS-334</b>
<b>163</b>	64 x 18½ x 15	Tapered	<b>BP-287</b>	<b>B-287</b>	<b>HS-287</b>	<b>HB-287</b>	<b>TS-335</b>
<b>172-K</b>	72 x 32	Rectangular	<b>BP-363</b>	<b>B-363</b>	<b>HS-363</b>	<b>HB-363</b>	<b>TS-336</b>
<b>187</b>	87 x 27	Flatwork Rectangular	<b>BP-415</b>	<b>B-415</b>	<b>HS-415</b>	<b>HB-415</b>	<b>TS-337</b>
<b>210</b>	13 x 7	Double Cuffs (2)	<b>BP-23</b>	<b>B-23</b>	<b>HS-23</b>	<b>HB-23</b>	<b>TS-553</b> (Set of 2)
<b>218</b>	17½ x 8	Oval Mushroom	<b>BP-44</b>	<b>B-44</b>	<b>HS-44</b>	<b>HB-44</b>	<b>TS-339</b>
<b>219</b>	19 x 10	Oval Mushroom	<b>BP-51</b>	<b>B-51</b>	<b>HS-51</b>	<b>HB-51</b>	<b>TS-340</b>

\* SPECIFY BARE BUCK  
or OVER SPRINGS

# LAUNDRY



## PROSPERITY FLATBED PRESSES

		COMBO	COVERS		PADS		
MFG. MODEL NUMBER	BUCK SIZE	DESCRIPTION	BONPAK NYLON COVER/PAD	BON-SPUN NYLON	HI-SPUN ARAMID	50 OZ. BONN-E-BLUE	TEXSTEEL STEEL BASE PAD*
<b>219</b>	19 x 10	Oval Mushroom (Electric)	N/A	N/A	HS-51	HB-51	TS-341
<b>222</b>	22 x 10	Yoke w/Cut-Out	BP-87	B-87	HS-87	HB-87	TS-342
<b>254</b>	54 x 20 <sup>1</sup> / <sub>2</sub>	Rectangular	BP-260	B-260	HS-260	HB-260	TS-343
<b>260</b>	60 x 30	Rectangular	BP-279	B-279	HS-279	HB-279	TS-344
<b>287-P</b>	87 x 27	Flatwork Rectangular	BP-415	B-415	HS-415	HB-415	TS-346
<b>316</b>	17 x 10 <sup>1</sup> / <sub>2</sub> x 7	Yoke w/Cut-Out	BP-34	B-34	HS-34	HB-34	TS-347
<b>321-PO</b>	21 x 10	Yoke w/Cut-Out	BP-87	B-87	HS-87	HB-87	TS-348
<b>351</b>	49 x 18 <sup>1</sup> / <sub>2</sub> x 9	Tapered	BP-230	B-230	HS-230	HB-230	TS-349
<b>352</b>	52 x 17	Rectangular	BP-239	B-239	HS-239	HB-239	TS-350
<b>387</b>	87 x 24	Flatwork Rectangular	BP-415	B-415	HS-415	HB-415	TS-351
<b>406-PC</b>	106 x 25 <sup>1</sup> / <sub>2</sub>	Flatwork Rectangular	BP-426	B-426	HS-426	HB-426	TS-548
<b>409</b>	13 x 12 <sup>1</sup> / <sub>2</sub> x 7- Left 13 x 12 <sup>1</sup> / <sub>2</sub> x 7- Right	Gusset Cuffs	BP-25 BP-734	B-25 B-734	HS-25 HS-734	HB-25 HB-734	TS-353 (Set of 2)
<b>421</b>	21 x 10	Rectangular	BP-86	B-86	HS-86	HB-86	TS-354
<b>438</b>	38 x 12 x 8	Tapered	BP-200	B-200	HS-200	HB-200	TS-355
<b>442</b>	42 x 18 <sup>1</sup> / <sub>2</sub> x 11	Legger w/Cut-Out	BP-214	B-214	HS-214	HB-214	TS-356
<b>451</b>	50 x 19 <sup>1</sup> / <sub>2</sub> x 9 <sup>1</sup> / <sub>2</sub>	Tapered	BP-230	B-230	HS-230	HB-230	TS-357
<b>454</b>	54 x 19 x 11	Tapered	BP-258	B-258	HS-258	HB-258	TS-358
<b>454</b>	54 x 19 x 11	Tapered (Electric)	N/A	N/A	HS-258	HB-258	TS-361
<b>520</b>	20 x 12 <sup>1</sup> / <sub>2</sub>	Yoke	BP-94	B-94	HS-94	HB-94	TS-362
<b>538-PC</b>	39 x 12 x 7	Tapered	BP-200	B-200	HS-200	HB-200	TS-363
<b>540-EL</b>	40 x 17 <sup>1</sup> / <sub>2</sub>	Body Bosom	BP-208	B-208	HS-208	HB-208	TS-366
<b>540-PC</b>	40 x 17 <sup>1</sup> / <sub>2</sub>	Body Bosom	BP-208	B-208	HS-208	HB-208	TS-368
<b>545</b>	46 x 18	Rectangular	BP-226	B-226	HS-226	HB-226	TS-549

\* SPECIFY BARE BUCK  
or OVER SPRINGS

# LAUNDRY



## PROSPERITY FLATBED PRESSES

MFG. MODEL NUMBER	BUCK SIZE	DESCRIPTION	COMBO	COVERS		PADS	
			BONPAK NYLON COVER/ PAD	BON-SPUN NYLON	HI-SPUN ARAMID	50 OZ. BONNE- BLUE	TEXSTEEL STEEL BASE PAD*
<b>549</b>	50 x 20 x 9 <sup>1</sup> / <sub>2</sub>	Tapered	<b>BP-234</b>	<b>B-234</b>	<b>HS-234</b>	<b>HB-234</b>	<b>TS-370</b>
<b>551</b>	49 <sup>1</sup> / <sub>2</sub> x 19 <sup>1</sup> / <sub>2</sub> x 8	Tapered	<b>BP-230</b>	<b>B-230</b>	<b>HS-230</b>	<b>HB-230</b>	<b>TS-372</b>
<b>552</b>	52 x 17	Rectangular	<b>BP-239</b>	<b>B-239</b>	<b>HS-239</b>	<b>HB-239</b>	<b>TS-373</b>
<b>553-PC</b>	53 x 18 x 12 <sup>1</sup> / <sub>2</sub>	Tapered	<b>BP-264</b>	<b>B-264</b>	<b>HS-264</b>	<b>HB-264</b>	<b>TS-374</b>
<b>554</b>	54 x 17	Rectangular	<b>BP-254</b>	<b>B-254</b>	<b>HS-254</b>	<b>HB-254</b>	<b>TS-375</b>
<b>621</b>	20 <sup>1</sup> / <sub>2</sub> x 9	Double Oval Mushroom (2)	<b>BP-67</b>	<b>B-67</b>	<b>HS-67</b>	<b>HB-67</b>	<b>TS-376</b> (Set of 2)
<b>642-PC</b>	42 x 24	Rectangular	<b>BP-213</b>	<b>B-213</b>	<b>HS-213</b>	<b>HB-213</b>	<b>TS-377</b>
<b>645-PC</b>	45 x 13 x 11 <sup>1</sup> / <sub>2</sub>	Boys Backer	<b>BP-221</b>	<b>B-221</b>	<b>HS-221</b>	<b>HB-221</b>	<b>TS-379</b>
<b>651</b>	51 x 16 x 8 <sup>1</sup> / <sub>2</sub>	Tapered	<b>BP-233</b>	<b>B-233</b>	<b>HS-233</b>	<b>HB-233</b>	<b>TS-380</b>
<b>654</b>	54 x 19 x 11	Legger w/Cut-Out	<b>BP-259</b>	<b>B-259</b>	<b>HS-259</b>	<b>HB-259</b>	<b>TS-381</b>
<b>721</b>	21 x 12 <sup>1</sup> / <sub>2</sub>	Oval Mushroom	<b>BP-102</b>	<b>B-102</b>	<b>HS-102</b>	<b>HB-102</b>	<b>TS-382</b>
<b>723</b>	22 <sup>1</sup> / <sub>2</sub> x 11 x 6	Yoke w/Cut-Out	<b>BP-119</b>	<b>B-119</b>	<b>HS-119</b>	<b>HB-119</b>	<b>TS-384</b>
<b>750</b>	48 x 14 <sup>1</sup> / <sub>2</sub> x 7 <sup>1</sup> / <sub>2</sub>	Tapered	<b>BP-227</b>	<b>B-227</b>	<b>HS-227</b>	<b>HB-227</b>	<b>TS-385</b>
<b>751</b>	50 x 16 x 8 <sup>1</sup> / <sub>2</sub>	Tapered	<b>BP-1039</b>	<b>B-1039</b>	<b>HS-1039</b>	<b>HB-1039</b>	<b>TS-386</b>
<b>821</b>	21 x 12	Yoke	<b>BP-94</b>	<b>B-94</b>	<b>HS-94</b>	<b>HB-94</b>	<b>TS-388</b>
<b>828</b>	15 x 7 x 6 x 5 9 x 7	Boy's Collar/Yoke Cuff	<b>BP-35</b> <b>BP-11</b>	<b>B-35</b> <b>B-11</b>	<b>HS-35</b> <b>HS-11</b>	<b>HB-35</b> <b>HB-11</b>	<b>TS-389</b> (Set of 2)
<b>921</b>	20 <sup>1</sup> / <sub>2</sub> x 9	Oval Mushroom	<b>BP-67</b>	<b>B-67</b>	<b>HS-67</b>	<b>HB-67</b>	<b>TS-391</b>
<b>922</b>	22 x 12 x 11 x 9	Rectangular Tapered	<b>BP-101</b>	<b>B-101</b>	<b>HS-101</b>	<b>HB-101</b>	<b>TS-392</b>
<b>924</b>	22 x 9	Collar	<b>BP-72</b>	<b>B-72</b>	<b>HS-72</b>	<b>HB-72</b>	<b>TS-393</b>
<b>940</b>	40 x 18	Body Bosom	<b>BP-208</b>	<b>B-208</b>	<b>HS-208</b>	<b>HB-208</b>	<b>TS-395</b>
<b>954</b>	54 x 19 x 12 <sup>1</sup> / <sub>2</sub>	Tapered	<b>BP-252</b>	<b>B-252</b>	<b>HS-252</b>	<b>HB-252</b>	<b>TS-396</b>
<b>1021</b>	20 <sup>1</sup> / <sub>2</sub> x 11	Yoke w/Cut-Out	<b>BP-68</b>	<b>B-68</b>	<b>HS-68</b>	<b>HB-68</b>	<b>TS-397</b>
<b>1024</b>	20 x 7	Shirt Collar	<b>BP-121</b>	<b>B-121</b>	<b>HS-121</b>	<b>HB-121</b>	<b>TS-398</b>

\* SPECIFY BARE BUCK

# LAUNDRY



## PROSPERITY FLATBED PRESSES

			COMBO	COVERS		PADS	
MFG. MODEL NUMBER	BUCK SIZE	DESCRIPTION	BONPAK NYLON COVER/PAD	BON-SPUN NYLON	HI-SPUN ARAMID	50 OZ. BONN-E-BLUE	TEXSTEEL STEEL BASE PAD*
<b>1025</b>	23 x 11 x 7	2-Lay Sleever	<b>CP-458</b>	<b>HB-458</b>	50 Oz. Bonn-E-Blue Pad		<b>TS-399</b>
<b>1040</b>	40 x 18	Body Bosom	<b>BP-208</b>	<b>B-208</b>	<b>HS-208</b>	<b>HB-208</b>	<b>TS-401</b>
<b>1221</b>	20 1/2 x 10	Yoke w/Cut-Out	<b>BP-85</b>	<b>B-85</b>	<b>HS-85</b>	<b>HB-85</b>	<b>TS-402</b>
<b>1236</b>	22 x 11 13 x 7	Collar/Yoke Cuff	<b>BP-90</b> <b>BP-23</b>	<b>B-90</b> <b>B-23</b>	<b>HS-90</b> <b>HS-23</b>	<b>HB-90</b> <b>HB-23</b>	<b>TS-403</b> (Set of 2)
<b>1236</b>	22 x 11 13 x 7	Collar/Yoke Cuff (Electric)	<b>N/A</b> <b>N/A</b>	<b>N/A</b> <b>N/A</b>	<b>HS-90</b> <b>HS-23</b>	<b>HB-90</b> <b>HB-23</b>	<b>TS-404</b> (Set of 2)
<b>1320</b>	20 x 13	Yoke	<b>BP-94</b>	<b>B-94</b>	<b>HS-94</b>	<b>HB-94</b>	<b>TS-405</b>
<b>1321</b>	22 x 11	Yoke w/Cut-Out	<b>BP-85</b>	<b>B-85</b>	<b>HS-85</b>	<b>HB-85</b>	<b>TS-406</b>
<b>1336</b>	36 x 12 x 10	Double End Pants Topper	<b>BP-184</b>	<b>B-184</b>	<b>HS-184</b>	<b>HB-184</b>	<b>TS-407</b>
<b>1421</b>	22 x 11	Yoke	<b>BP-110</b>	<b>B-110</b>	<b>HS-110</b>	<b>HB-110</b>	<b>TS-408</b>
<b>2222</b>	22 x 12 - Left 22 x 12 - Right	Double Sleever	<b>BP-467</b> <b>BP-610</b>	<b>B-467</b> <b>B-610</b>	<b>HS-467</b> <b>HS-610</b>	<b>HB-467</b> <b>HB-610</b>	<b>TS-410</b> (Set of 2)
<b>2240</b>	20 x 7 13 x 7	Collar Cuffs (2)	<b>BP-81</b> <b>BP-23</b>	<b>B-81</b> <b>B-23</b>	<b>HS-81</b> <b>HS-23</b>	<b>HB-81</b> <b>HB-23</b>	<b>TS-412</b> (Set of 3)
<b>2440</b>	20 x 7 13 x 7	Collar Cuffs (2)	<b>BP-72**</b> <b>BP-20**</b>	<b>B-72**</b> <b>B-20**</b>	<b>HS-72**</b> <b>HS-20**</b>	<b>HB-72</b> <b>HB-20</b>	<b>TS-413</b> (Set of 3)
<b>2540</b>	40 1/2 x 18 1/2 x 17	Body Bosom	<b>BP-208</b>	<b>B-208</b>	<b>HS-208</b>	<b>HB-208</b>	<b>TS-414</b>
<b>2740</b>	40 1/2 x 20 x 19	Body Bosom	<b>BP-204</b>	<b>B-204</b>	<b>HS-204</b>	<b>HB-204</b>	<b>TS-415</b>
<b>3140</b>	24 x 7 12 1/2 x 7	Collar Gusset Cuffs (2)	<b>BP-72</b> <b>BP-25</b>	<b>B-72</b> <b>B-25</b>	<b>HS-72</b> <b>HS-25</b>	<b>HB-72</b> <b>HB-25</b>	<b>TS-416</b> (Set of 3)
<b>3240</b>	39 1/2 x 20 x 19	Body Bosom	<b>BP-198</b>	<b>B-198</b>	<b>HS-198</b>	<b>HB-198</b>	<b>TS-417</b>
<b>3540</b>	20 x 11 13 x 7	Collar/Yoke Cuffs (2)	<b>BP-56</b> <b>BP-20</b>	<b>B-56</b> <b>B-20</b>	<b>HS-56</b> <b>HS-20</b>	<b>HB-56</b> <b>HB-20</b>	<b>TS-418</b> (Set of 3)
<b>3840</b>	20 x 7 x 6 13 x 7	Collar Cuffs (2)	<b>BP-72**</b> <b>BP-20**</b>	<b>B-72**</b> <b>B-20**</b>	<b>HS-72**</b> <b>HS-20**</b>	<b>HB-72</b> <b>HB-20</b>	<b>TS-419</b> (Set of 3)

\*\* For Skirted Tie-On Covers,  
order the following Bonnco Codes:

**Collar        89**  
**Cuff            24**

\* SPECIFY BARE BUCK  
or OVER SPRINGS

# LAUNDRY



## ROTONDI COLLAR & CUFF

MFG. MODEL NUMBER	Buck Size	Description	WHITE ARAMID COVER	SILICONE PAD
1160	30 x 15	Collar & Cuff (Continuous)	WA-2182	M-2424

## SAILSTAR COLLAR & CUFF

MFG. MODEL NUMBER	Buck Size	Description	COMBO	COVERS		PAD	
			BONPAK NYLON COVER/PAD	BON-SPUN NYLON	HI-SPUN ARAMID	50 OZ. BONN-E-BLUE	TEXSTEEL STEEL BASE PAD
CCW-C	21 x 7	Collar	BP-89	B-89	HS-89	HB-89	TS-8
	13 x 7	Cuffs (2)	BP-24	B-24	HS-24	HB-24	(Set of 3)



**SANKOSHA  
EQUIPMENT**

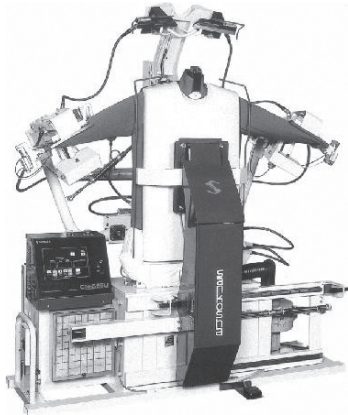

CN-567

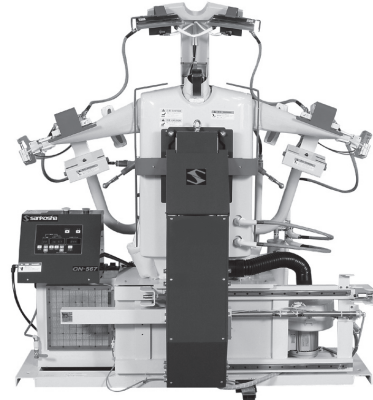

CN-565

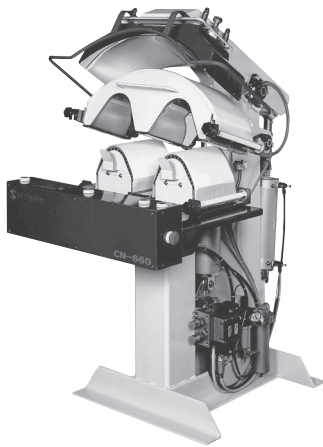

CN-660

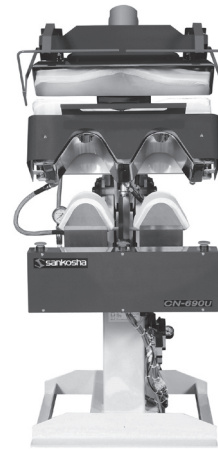

CN-690

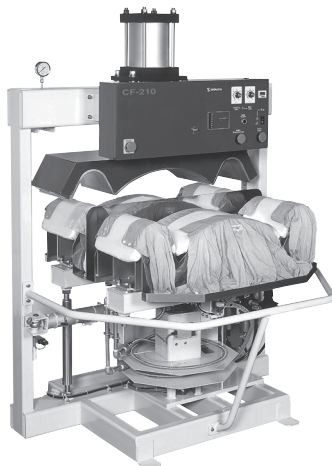

CF-210

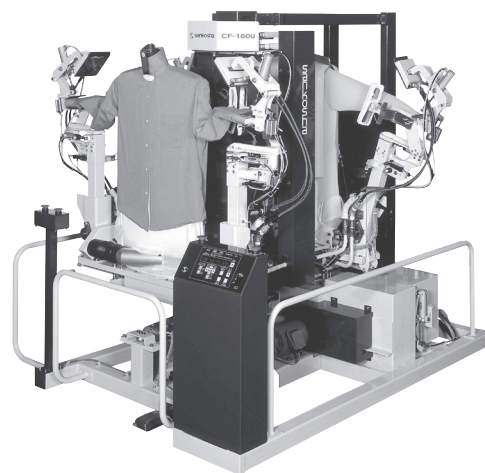

CF-160



**SANKOSHA  
EQUIPMENT**

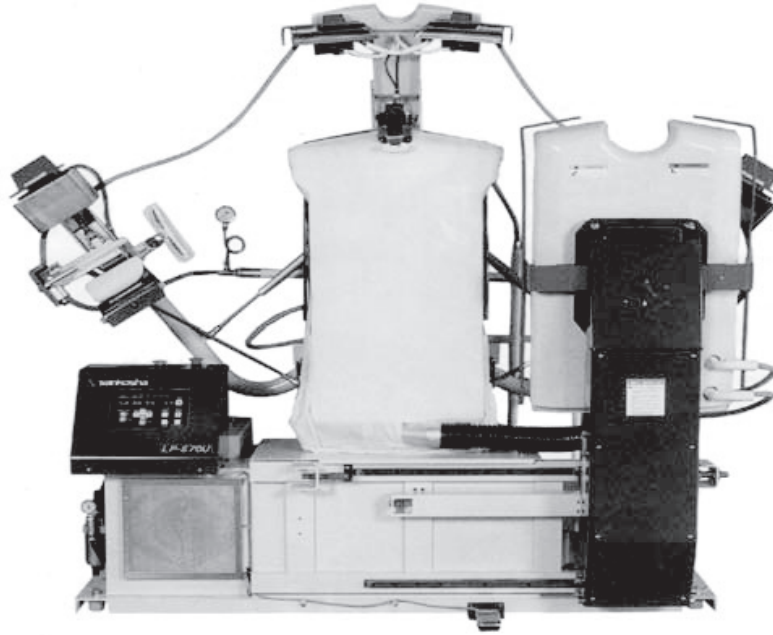

**LP-570-U**



Buckeye has adapted a "Quick Connect" Velcro string assembly into each of our Sankosha body covers. This connection will provide an airtight seal at the bottom of our covers, and will allow for easy installation with no more cumbersome and confusing strings to tie.

**SANKOSHA EXPANDERS**

**MODELS\***

- ALP-550-U**
- CF-160 CONVERTED**
- CF-161**
- CN-561 CONVERTED**
- CN-565 CONVERTED**
- CN-566**
- CN-567**
- LP-170-U**
- LP-175-U**
- LP-570-U**
- LP-575-U**

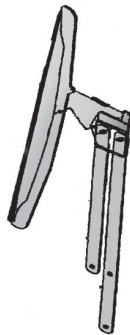

**\*CONVERTED**

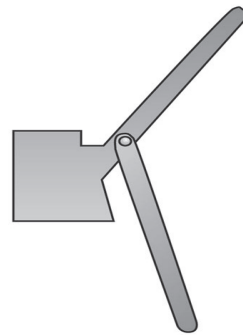

**\*\*STANDARD**

**MODELS\*\***

- CN-561**
- CN-565**
- CF-160**



## SANKOSHA/AJAX SINGLE BUCK SHIRT PRESS

MFG. MODEL NUMBER	WHITE ARAMID BUCK COVER	BUCK PADS (REQUIRES 1 EACH)	TUCK COVERS AND PADS	CUFF CLAMP COVER	ARAMID TAIL CLAMP COVER/PAD	COLLAR CLAMP COVER	SHORT SLEEVE COVER	SILICONE BASE PAD
ALP-550-U	WA-2098	FB-1722 (1) (30 OZ.) HB-1722 (1) (50 OZ.)	S-1893- Left S-1894- Right DB-1780* FM-1780*	1844**	WADB-1846	1293	1725*	RS-1722

\* Requires 2  
\*\* Requires 4

## SANKOSHA SINGLE BUCK SHIRT PRESS

MFG. MODEL NUMBER	WHITE ARAMID BUCK COVER	30OZ. BUCK PAD (2 EACH)	TUCK COVER AND PADS	CUFF CLAMP COVER	ARAMID TAIL CLAMP COVER	TAIL CLAMP PAD	COLLAR CLAMP COVER	SHORT SLEEVE COVER	SILICONE BASE PAD
CN-561	WA-1722	FB-1722*	S-1723* DB-1723* FM-1723*	1844**	WA-1724	DB-1724	1293	1725*	RS-1722
CN-561 Converted	WA-1895	FB-1722*	S-1723* DB-1723* FM-1723*	1844**	WA-1724	DB-1724	1293	1725*	RS-1722

\* Requires 2  
\*\* Requires 4

## SANKOSHA SINGLE BUCK SHIRT PRESS

MFG. MODEL NUMBER	WHITE ARAMID BUCK COVER	30OZ. BUCK PAD (2 EACH)	TUCK COVER AND PADS	CUFF CLAMP COVER	ARAMID TAIL CLAMP COVER/PAD	COLLAR CLAMP COVER	SHORT SLEEVE COVER	SILICONE BASE PAD
CN-565	WA-1790	FB-1722*	S-1933* DB-1780* FM-1780*	1844**	WADB-1846	1293	1725*	RS-1722
CN-565 Converted	WA-1808	FB-1722*	S-1933* DB-1780* FM-1780*	1844**	WADB-1846	1293	1725*	RS-1722
CN-566	WA-1808	FB-1722*	S-1893-Left S-1894-Right DB-1780* FM-1780*	1844**	WADB-1846	1293	1725*	RS-1722
CN-567	WA-1857	FB-1722*	S-1893-Left S-1894-Right DB-1780* FM-1780*	1844**	WADB-1846	1293	1725*	RS-1722

\* Requires 2  
\*\* Requires 4



## SANKOSHA SINGLE BUCK SHIRT PRESS

MFG. MODEL NUMBER	WHITE ARAMID BUCK COVER	BUCK PADS (REQUIRES 1 EACH)	TUCK COVERS AND PADS		CUFF CLAMP COVER	ARAMID TAIL CLAMP COVER/PAD	COLLAR CLAMP COVER	SHORT SLEEVE COVER	SILICONE BASE PAD
LP-570-U LP-575-U	WA-2098	FB-1722 (1) (30 OZ.)  HB-1722 (1) (50 OZ.)	TOP: WK-2141* DB-2141* FM-2141*	BOTTOM LEFT: WK-2143 DB-2143 RS-2143  BOTTOM RIGHT: WK-2145 DB-2143 RS-2143	2147*	WAFB-2149	1293	FRONT: 2146*  REAR: 2144*	RS-1722
LP-580-U	WA-2465	FBA-2465 (1) (30 OZ. w/ AIRBAG)  HB-2472 (1) (50 OZ.)	TOP: WK-2141* DB-2141* FM-2141*	BOTTOM LEFT: WK-2143 DB-2143 RS-2143  BOTTOM RIGHT: WK-2145 DB-2143 RS-2143	2147*	SMH-2473	1293	FRONT: 2146*  REAR: 2144*	RS-1722
LP-580-U-V2 LP-590	WA-2465	FBA-2465 (1) (30 OZ. w/ AIRBAG)  SL-2472 (1) (80 OZ.)	TOP: WK-2141* DB-2141* FM-2141*	BOTTOM LEFT: WK-2143 DB-2143 RS-2143  BOTTOM RIGHT: WK-2145 DB-2143 RS-2143	2147*	SMH-2473	1293	FRONT: 2146*  REAR: 2144*	RS-2500

\* Requires 2

# LAUNDRY



## SANKOSHA DOUBLE BUCK SHIRT PRESS

MFG. MODEL NUMBER	WHITE ARAMID BUCK COVER	30 OZ. BUCK PAD (2 EACH)	TUCK COVER AND PADS	CUFF CLAMP COVER	ARAMID TAIL CLAMP COVER/PAD	COLLAR CLAMP COVER	SHORT SLEEVE COVER	SILICONE BASE PAD
CF-160	WA-1790	FB-1722*	S-1878* DB-1878* FM-1878*	1844**	WADB-1846	1293	FRONT: 1725*  REAR: 2144*	RS-1722
CF-160 Converted	WA-1808	FB-1722*	S-1878* DB-1878* FM-1878*	1844**	WADB-1846	1293	FRONT: 1725*  REAR: 2144*	RS-1722
CF-161	WA-1857	FB-1722*	S-1893 - Left S-1894 - Right DB-1780* FM-1780*	1844**	WADB-1846	1293	FRONT: 1725*  REAR: 2144*	RS-1722

\* Requires 2

\*\* Requires 4

MFG. MODEL NUMBER	WHITE ARAMID BUCK COVER	BUCK PADS (REQUIRES 1 EACH)	TUCK COVERS AND PADS		CUFF CLAMP COVER	ARAMID TAIL CLAMP COVER/PAD	COLLAR CLAMP COVER	SHORT SLEEVE COVER	SILICONE BASE PAD
LP-170-U LP-175-U LP-185-U	WA-2098	FB-1722 (1) (30 OZ.)  HB-1722 (1) (50 OZ.)	TOP: WK-2141* DB-2141* FM-2141*	BOTTOM LEFT: WK-2143 DB-2143 RS-2143  BOTTOM RIGHT: WK-2145 DB-2143 RS-2143	2147*	WAFB-2149	1293	FRONT: 2146*  REAR: 2144*	RS-1722
LP-190-U	WA-2465	FBA-2465 (1) (30 OZ. w/ AIRBAG)  SL-2472 (1) (80 OZ.)	TOP: WK-2141* DB-2141* FM-2141*	BOTTOM LEFT: WK-2143 DB-2143 RS-2143  BOTTOM RIGHT: WK-2145 DB-2143 RS-2143	2147*	SMH-2473	1293	FRONT: 2146*  REAR: 2144*	RS-2500

\* Requires 2

**INSTALLATION VIDEO FOR THE SANKOSHA LP-190-U UNIT CAN BE FOUND ON OUR WEBSITE [www.fhbonn.com](http://www.fhbonn.com); OR YOU CAN SCAN THE FOLLOWING**



# LAUNDRY



## SANKOSHA COLLAR & CUFF UNITS

MFG. MODEL NUMBER	DESCRIPTION	COVERS		PADS	
		ARAMID COVER	BON-SPUN NYLON	PAD	SILICONE BASE PAD
<b>CF-200</b> (CF204: Serial # before 25071)	Rotary Collar (4) Cuffs (8)	<b>WA-1720</b> <b>WA-1721</b>	<b>B-1720</b> <b>B-1721</b>	<b>HB-1720 (50 oz)</b> <b>HB-1721 (50 oz)</b>	<b>CS-2615</b> (Set of 12)
<b>CF-200 (CF205/206 Serial # 25101 &amp; after)</b>	Collar (4) Cuffs (4) French Cuffs (4)	<b>WA-2611</b> <b>WA-1721</b> <b>WA-1726</b>	<b>B-2611</b> <b>B-1721</b> <b>B-1726</b>	<b>HB-2611 (50 oz)</b> <b>HB-1721 (50 oz)</b> <b>HB-1726 (50 oz)</b>	<b>CS-2611</b> (Set of 12)
<b>CF-210 - CF-210U</b>	Collar (2) Cuffs (4)	<b>WA-1941</b> <b>WA-1944</b>	<b>B-1941</b> <b>B-1944</b>	<b>FB-1941 (30 oz)</b> <b>FB-1944 (30 oz)</b>	<b>PS-1941</b> (Set of 6)
<b>CN250 Double</b>	Collar (2) French Cuffs (4)	<b>WA-1720</b> <b>WA-1726</b>	<b>N/A</b> <b>N/A</b>	<b>HB-1720 (50 oz)</b> <b>HB-1726 (50 oz)</b>	<b>CS-2620</b> (Set of 6)
<b>LP300U Double</b>	Collar (2) Left Cuff (2) Right Cuff (2)	<b>WA-2175</b> <b>WA-2177</b> <b>WA-2181</b>	<b>N/A</b> <b>N/A</b> <b>N/A</b>	<b>DB-2175 (20 oz)</b> <b>DB-2177 (20 oz)</b> <b>DB-2177 (20 oz)</b>	<b>CS-2175</b> (Set of 6)
<b>LP370U/ LP370V2 Double</b>	Collar (2) Cuffs (4)	<b>WA-2243</b> <b>SM-2245</b>	<b>N/A</b> <b>N/A</b>	<b>FB-2243 (30 oz)</b> <b>SET JUD-2245</b>	<b>CS-2243</b> (Set of 7)
<b>CN600U/ CN660U Continuous Cuff</b>	Collar (1) Cuff (1)	<b>WA-1729</b> <b>WA-1728</b>	<b>N/A</b> <b>N/A</b>	<b>FB-1729 (30 oz)</b> <b>FB-1728 (2) (30 oz)</b>	<b>CS-1729</b> (Set of 3)
<b>CN650 (Serial #1-135)</b>	Collar (1) Cuff (2)	<b>WA-1720</b> <b>WA-1721</b>	<b>B-1720</b> <b>B-1721</b>	<b>HB-1720 (50 oz)</b> <b>HB-1721 (50 oz)</b>	
<b>CN650 (Serial #65121, 65122, 65126, 65132, 65134, 65136 &amp; after)</b>	Collar (1) French Cuffs (2)	<b>WA-1720</b> <b>WA-1726</b>	<b>B-1720</b> <b>B-1726</b>	<b>HB-1720 (50 oz)</b> <b>HB-1726 (50 oz)</b>	<b>CS-1726</b> (Set of 3)
<b>ALP-600U LP660-U</b>	Collar (1) Right Cuff (1) Left Cuff (1)	<b>WA-1855</b> <b>WA-1853</b> <b>WA-1845</b>	<b>N/A</b> <b>N/A</b> <b>N/A</b>	<b>FB-1855 (30 oz)</b> <b>FB-1853 (30 oz)</b> <b>FB-1845 (30 oz)</b>	<b>CS-1855</b> (Set of 3)
<b>CN680/681</b>	Collar (1) Right Cuff (1) Left Cuff (1)	<b>SM-2268</b> <b>SM-2266</b> <b>SM-2263</b>	<b>N/A</b> <b>N/A</b> <b>N/A</b>	<b>SET SL-2268 (80 oz)</b> <b>SET-JUD-2263</b> <b>SET-JUD-2263</b>	
<b>LP685</b>	Collar (1) Cuffs (2)	<b>WA-2545</b> <b>WA-2547</b>	<b>N/A</b> <b>N/A</b>	<b>HB-2545 (50 oz)</b> <b>HB-2547 (50 oz)</b>	<b>CS-2545</b> (Set of 3)
<b>CN690U/691 SCN690U</b>	Collar (1) Cuffs (2)	<b>WA-1897</b> <b>WA-1898</b>	<b>N/A</b> <b>N/A</b>	<b>DB-1897 (20 oz)</b> <b>SET JUD-1898</b>	<b>RS-1897</b> (Set of 3)
<b>LP690U</b>	Collar (1) Cuffs (2)	<b>WA-1897</b> <b>WA-1898</b>	<b>N/A</b> <b>N/A</b>	<b>FB-1897 (30 oz)</b> <b>SET JUD-1898</b>	<b>RS-2672</b> (Set of 7)
<b>LP690EV2 LP690UV2 LP690V3</b>	Collar (1) Right Cuff (1) Left Cuff (1)	<b>WA-1897</b> <b>SM-2440</b> <b>SM-2441</b>	<b>N/A</b> <b>N/A</b> <b>N/A</b>	<b>FB-1897 (30 oz)</b> <b>SET JUFB-2442</b> <b>SET JUFB-2442</b>	<b>CS-2550</b> (Set of 7)

# LAUNDRY



## SANKOSHA/AJAX FLATBED PRESSES

MFG. MODEL NUMBER	BUCK SIZE	DESCRIPTION	COMBO	COVERS		PADS		TEXSTEEL STEEL BASE PAD BARE BUCK
			BONPAK NYLON COVER/ PAD	BON-SPUN NYLON	HI-SPUN ARAMID	50 OZ. BONN-E- BLUE		
<b>AHP-218-U</b>	18 <sup>1</sup> / <sub>4</sub> x 18	Mushroom	<b>BP-2122</b>	<b>B-2122</b>	<b>HS-2122</b>	<b>HB-2122</b>	<b>TS-2122</b>	
<b>AHP-336-U</b>	36 x 12	Double End Pant Topper	<b>BP-184</b>	<b>B-184</b>	<b>HS-184</b>	<b>HB-184</b>	<b>TS-112</b>	
<b>AHP-450-U</b>	50 x 14 <sup>1</sup> / <sub>2</sub> x 9	Tapered	<b>BP-2124</b>	<b>B-2124</b>	<b>HS-2124</b>	<b>HB-2124</b>	<b>TS-2124</b>	
<b>AHP-554-U</b>	54 x 18 x 10 <sup>3</sup> / <sub>4</sub>	Tapered	<b>BP-2126</b>	<b>B-2126</b>	<b>HS-2126</b>	<b>HB-2126</b>	<b>TS-2126</b>	
<b>AHP-654-U</b>	54 x 18	Rectangular	<b>BP-2128</b>	<b>B-2128</b>	<b>HS-2128</b>	<b>HB-2128</b>	<b>TS-2128</b>	
<b>LP-250</b>	42 x 12 x 9	Utility	<b>BP-2132</b>	<b>B-2132</b>	<b>HS-2132</b>	<b>HB-2132</b>	<b>TS-2132</b>	
<b>LP-260</b>	50 X 14 <sup>1</sup> / <sub>4</sub> X 9	Tapered	<b>BP-2124</b>	<b>BT-2124</b>	<b>B-2124</b>	<b>HS-2124</b>	<b>HB-2124</b>	<b>TS-2124</b>

## SILVERSTAR FLATBED PRESSES

MFG. MODEL NUMBER	BUCK SIZE	DESCRIPTION	BON-SPUN NYLON COVER	50 OZ. BONN-E-BLUE PAD
<b>SJAS</b>	21 <sup>3</sup> / <sub>4</sub> x 8 <sup>3</sup> / <sub>4</sub> 11 <sup>1</sup> / <sub>2</sub> x 6 <sup>1</sup> / <sub>2</sub>	Collar Cuffs (2)	<b>B-1181</b> <b>B-1184</b>	<b>HB-1181</b> <b>HB-1184</b>

## HOT AIR SHIRT FINISHERS

MFG. MODEL NUMBER	DESCRIPTION	FORM COVER	HI-SPUN ARAMID CLAMP COVER	21 OZ. PRYME CLAMP PAD	COLLAR PLATE COVER/PAD	1" X 90" WEBBING FOR BELT
<b>SY</b>	Shirt Form	<b>PF-959</b> OR <b>PF-1355</b> With Metal Stays in Sleeves	<b>HS-1208</b>	<b>D-1208</b>	<b>PFD-1360</b>	<b>1665</b>

## TREVIL FLATBED PRESSES

MFG. MODEL NUMBER	BUCK SIZE	DESCRIPTION	WHITE ARAMID COVER/PAD
<b>6311</b>	26 x 10 15 x 8	Collar Cuffs (2)	<b>WADB-2077</b> <b>WADB-2078</b>

# LAUNDRY



## TROY FLATBED PRESSES

MFG. MODEL NUMBER	BUCK SIZE	DESCRIPTION	COMBO	COVERS		PADS	
			BONPAK NYLON COVER/ PAD	BON-SPUN NYLON	HI-SPUN ARAMID	50 OZ. BONN-E- BLUE	TEXSTEEL STEEL BASE PAD*
<b>16-C</b>	16½ x 10½	Yoke w/Cut-Out	<b>BP-34</b>	<b>B-34</b>	<b>HS-34</b>	<b>HB-34</b>	<b>TS-420</b>
<b>18-A</b>	17½ x 8	Oval Mushroom	<b>BP-44</b>	<b>B-44</b>	<b>HS-44</b>	<b>HB-44</b>	<b>TS-421</b>
<b>18-B</b>	17½ x 8	Oval Mushroom	<b>BP-44</b>	<b>B-44</b>	<b>HS-44</b>	<b>HB-44</b>	<b>TS-423</b>
<b>21-A</b>	21 x 10	Oval Mushroom	<b>BP-67</b>	<b>B-67</b>	<b>HS-67</b>	<b>HB-67</b>	<b>TS-424</b>
<b>21-B</b>	21 x 10	Oval Mushroom	<b>BP-67</b>	<b>B-67</b>	<b>HS-67</b>	<b>HB-67</b>	<b>TS-425</b>
<b>21-C</b>	21 x 12	Yoke	<b>BP-94</b>	<b>B-94</b>	<b>HS-94</b>	<b>HB-94</b>	<b>TS-426</b>
<b>21-E</b>	21 x 10	Yoke w/Cut-Out	<b>BP-87</b>	<b>B-87</b>	<b>HS-87</b>	<b>HB-87</b>	<b>TS-427</b>
<b>21-F</b>	21 x 10½	Rectangular	<b>BP-86</b>	<b>B-86</b>	<b>HS-86</b>	<b>HB-86</b>	<b>TS-428</b>
<b>21-H</b>	18 x 10	Oval Mushroom	<b>BP-51</b>	<b>B-51</b>	<b>HS-51</b>	<b>HB-51</b>	<b>TS-429</b>
<b>37-C</b>	37 x 17	Body Bosom	<b>BP-189</b>	<b>B-189</b>	<b>HS-189</b>	<b>HB-189</b>	<b>TS-430</b>
<b>38</b>	37 x 12 x 8½	Tapered	<b>BP-200</b>	<b>B-200</b>	<b>HS-200</b>	<b>HB-200</b>	<b>TS-431</b>
<b>40-B</b>	40 x 17½	Body Bosom	<b>BP-208</b>	<b>B-208</b>	<b>HS-208</b>	<b>HB-208</b>	<b>TS-432</b>
<b>40-BC</b>	41 x 19 x 18	Body Bosom	<b>BP-204</b>	<b>B-204</b>	<b>HS-204</b>	<b>HB-204</b>	<b>TS-434</b>
<b>40-C</b>	40 x 17½	Body Bosom	<b>BP-208</b>	<b>B-208</b>	<b>HS-208</b>	<b>HB-208</b>	<b>TS-435</b>
<b>51</b>	50 x 18 x 9	Tapered	<b>BP-234</b>	<b>B-234</b>	<b>HS-234</b>	<b>HB-234</b>	<b>TS-436</b>
<b>51-38</b>	50 x 15 x 9	Tapered	<b>BP-233</b>	<b>B-233</b>	<b>HS-233</b>	<b>HB-233</b>	<b>TS-438</b>
<b>54</b>	54 x 19 x 11	Tapered	<b>BP-258</b>	<b>B-258</b>	<b>HS-258</b>	<b>HB-258</b>	<b>TS-439</b>
<b>54-A</b>	54 x 18½	Rectangular	<b>BP-254</b>	<b>B-254</b>	<b>HS-254</b>	<b>HB-254</b>	<b>TS-441</b>
<b>5138</b>	50 x 15 x 9	Tapered	<b>BP-233</b>	<b>B-233</b>	<b>HS-233</b>	<b>HB-233</b>	<b>TS-442</b>

\* SPECIFY BARE BUCK  
or OVER SPRINGS



BON-TWILL COVER  
WITH 50 OZ. PAD

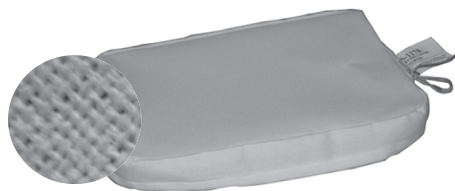

HI-SPUN ARAMID COVER

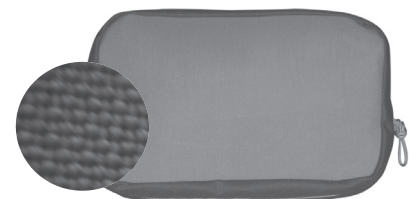

BON-SPUN NYLON COVER

**UNIPRESS  
EQUIPMENT**



PCZ



ABS

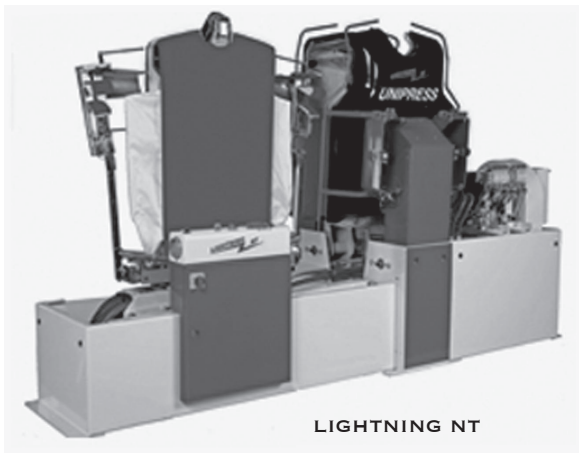

LIGHTNING NT



PCF



3TZ



CRDC



## UNIPRESS

### HURRICANE HS CABINET AIR BAG BODY PRESS

MFG. MODEL NUMBER	DESCRIPTION	OPEN WEAVE ARAMID COVER W/ 30 OZ PRYME FLANNEL W/ MESH TOP	NARROW AIR BAG	LARGE AIR BAG	PADDLE COVERS	CUFF CLAMPS COVER/ PAD	TAIL CLAMP COVER PAD	TAIL CLAMP TEXSTEEL STEEL BASE PAD	BODY TEXSTEEL STEEL BASE PAD
<b>HS</b>	Single Buck	<b>ROWNF-2470 (RED)</b> —OR— <b>OWNF-2470 (NATURAL)</b>	<b>U-2700</b>	<b>U-2725</b>	<b>2314–Left</b>  <b>2316–Right</b>	<b>2324*</b> <b>2702*</b> <b>2704*</b>	<b>2466</b>	<b>TS-2463</b>	<b>TS-2460</b>

\* Requires 2

### HS1 CABINET AIR BAG BODY PRESS WITH COLLAR & CUFF

MFG. MODEL NUMBER	DESCRIPTION	OPEN WEAVE ARAMID COVER W/ 30 OZ PRYME FLANNEL W/ MESH TOP	NARROW AIR BAG	LARGE AIR BAG	PADDLE COVERS	CUFF CLAMPS COVER/ PAD	TAIL CLAMP COVER PAD	TAIL CLAMP TEXSTEEL STEEL BASE PAD	BODY TEXSTEEL STEEL BASE PAD
<b>HS1</b>	Single Buck	<b>ROWNF-2470 (RED)</b> —OR— <b>OWNF-2470 (NATURAL)</b>	<b>U-2700</b>	<b>U-2725</b>	<b>2314–Left</b>  <b>2316–Right</b>	<b>2324*</b> <b>2702*</b> <b>2704*</b>	<b>2466</b>	<b>TS-2463</b>	<b>TS-2460</b>

\* Requires 2

MFG. MODEL NUMBER	BUCK SIZE	DESCRIPTION	RED OPEN WEAVE ARAMID COVER	50 OZ BONN-E-BLUE PAD	30 OZ BONN-E-BLUE PAD	TEXSTEEL STEEL BASE PAD**
<b>HS1 (L3T) Collar &amp; Cuff</b>	19 x 7 12 x 7	Collar Cuff (2)	<b>ROWNF-1179</b> <b>ROWNF-1178</b>	<b>HB-1179</b> <b>HB-1178</b>	<b>FB-1179</b> <b>FB-1178</b>	<b>TS-476 (Set of 3)</b>

\*\* WHEN ORDERING NEW TEXSTEEL BASE PADS, USE 30 OZ. PADDING.

### HS2 CABINET AIR BAG BODY PRESS

MFG. MODEL NUMBER	DESCRIPTION	OPEN WEAVE ARAMID COVER W/ 30 OZ PRYME FLANNEL W/ MESH TOP	NARROW AIR BAG	LARGE AIR BAG	PADDLE COVERS	CUFF CLAMPS COVER/ PAD	TAIL CLAMP COVER	TAIL CLAMP TEXSTEEL STEEL BASE PAD	BODY TEX-STEEL STEEL BASE PAD
<b>HS2</b>	Double Buck	<b>ROWNF-2470 (RED)</b> —OR— <b>OWNF-2470 (NATURAL)</b>	<b>U-2700</b>	<b>U-2725</b>	<b>2314–Left</b>  <b>2316–Right</b>	<b>2324*</b> <b>2702*</b> <b>2704*</b>  (See diagram on LA67)	<b>2466</b>	<b>TS-2463</b>	<b>TS-2460</b>

\* Requires 2



## UNIPRESS

### LIGHTNING LS CABINET AIR BAG BODY PRESS

MFG. MODEL NUMBER	DESCRIPTION	OPEN WEAVE ARAMID COVER W/ 30 OZ PRYME FLANNEL W/ MESH TOP	NARROW AIR BAG	LARGE AIR BAG	PADDLE COVERS	CUFF CLAMPS COVER/ PAD	TAIL CLAMP COVER PAD	TAIL CLAMP TEXSTEEL STEEL BASE PAD	BODY TEXSTEEL STEEL BASE PAD
<b>LS</b>	Single Buck	<b>ROWNF-2470 (RED)</b> —OR— <b>OWNF-2470 (NATURAL)</b>	<b>U-2475</b>	<b>U-2460</b>	<b>2314–Left</b>  <b>2316–Right</b>	<b>2324*</b> <b>2312*</b> <b>2318 *</b>  (See diagram on LA68)	<b>2466</b>	<b>TS-2463</b>	<b>TS-2460</b>

\* Requires 2

### LS1 CABINET AIR BAG BODY PRESS WITH COLLAR & CUFF

MFG. MODEL NUMBER	DESCRIPTION	OPEN WEAVE ARAMID COVER W/ 30 OZ PRYME FLANNEL W/ MESH TOP	NARROW AIR BAG	LARGE AIR BAG	PADDLE COVERS	CUFF CLAMPS COVER/ PAD	TAIL CLAMP COVER PAD	TAIL CLAMP TEXSTEEL STEEL BASE PAD	BODY TEXSTEEL STEEL BASE PAD
<b>LS 1</b>	Single Buck	<b>ROWNF-2470 (RED)</b> —OR— <b>OWNF-2470 (NATURAL)</b>	<b>U-2475</b>	<b>U-2460</b>	<b>2314 –Left</b>  <b>2316 –Right</b>	<b>2324*</b> <b>2312*</b> <b>2318 *</b>  (See diagram on LA68)	<b>2466</b>	<b>TS-2463</b>	<b>TS-2460</b>

\* Requires 2

MFG. MODEL NUMBER	BUCK SIZE	DESCRIPTION	RED OPEN WEAVE ARAMID COVER	50 OZ BONN-E-BLUE PAD	30 OZ BONN-E-BLUE PAD	TEXSTEEL STEEL BASE PAD**
<b>LS1 (L3T) Collar &amp; Cuff</b>	19 x 7 12 x 7	Collar Cuff (2)	<b>ROWN-1179</b> <b>ROWN-1178</b>	<b>HB-1179</b> <b>HB-1178</b>	<b>FB-1179</b> <b>FB-1178</b>	<b>TS-476 (Set of 3)</b>

\*\* WHEN ORDERING NEW TEXSTEEL BASE PADS, USE 30 OZ. PADDING.

### LS2 CABINET AIR BAG BODY PRESS

MFG. MODEL NUMBER	DESCRIPTION	OPEN WEAVE ARAMID COVER W/ 30 OZ PRYME FLANNEL W/ MESH TOP	NARROW AIR BAG	LARGE AIR BAG	PADDLE COVERS	CUFF CLAMPS COVER/ PAD	TAIL CLAMP COVER	TAIL CLAMP TEXSTEEL STEEL BASE PAD	BODY TEX-STEEL STEEL BASE PAD
<b>LS2</b>	Double Buck	<b>ROWNF-2470 (RED)</b> —OR— <b>OWNF-2470 (NATURAL)</b>	<b>U-2475</b>	<b>U-2460</b>	<b>2314 –Left</b>  <b>2316 –Right</b>	<b>2324*</b> <b>2312*</b> <b>2318 *</b>  (See diagram on LA68)	<b>2466</b>	<b>TS-2463</b>	<b>TS-2460</b>

\* Requires 2

INSTALLATION VIDEO FOR THE LS UNIT CAN BE FOUND ON OUR WEBSITE [www.fhbonn.com](http://www.fhbonn.com).  
OR YOU CAN SCAN THE FOLLOWING CODE TO YOUR SMART PHONE TO DOWNLOAD.





**UNIPRESS**  
LIGHTNING LS/LS-1/LS-2

**2314**  
PADDLE COVER  
SET-LEFT

**2316**  
PADDLE COVER  
SET-RIGHT

**ROWNF-2470**  
RED COVER & FLANNEL SET

**U-2475**  
AIR BAG

**2324 (2)**  
TOP CUFF CLAMP COVER

**2312 (2)**  
CENTER CUFF CLAMP COVER  
WITH ZIPPER

**2318 (2)**  
BOTTOM CUFF CLAMP COVER

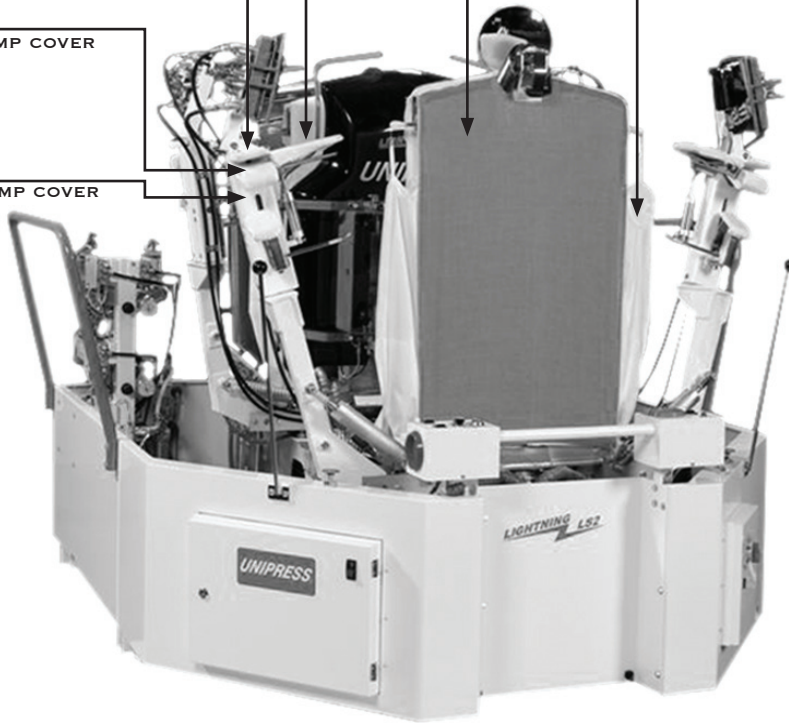

**2466**  
REAR TAIL CLAMP  
COVER SET

# LAUNDRY



## UNIPRESS

### LIGHTNING AP CABINET AIR BAG BODY PRESS

MFG. MODEL NUMBER	DESCRIPTION	OPEN WEAVE ARAMID COVER W/ 30 OZ PRYME FLANNEL W/ MESH TOP	AIR BAG	PADDLE COVERS	CUFF CLAMPS COVER/PAD	TEXSTEEL STEEL BASE PAD
<b>AP</b>	Single Buck	<b>ROWNF-1892 (RED)</b> —OR— <b>OWNF-1892 (NATURAL)</b>	<b>U-2310</b>	<b>2314 – Left</b>  <b>2316 – Right</b>	<b>2324*</b> <b>2312*</b> <b>2318 *</b> (See diagram on LA68)	<b>TS-1888</b>

\* Requires 2

### LIGHTNING AP1 CABINET AIR BAG BODY PRESS W/COLLAR & CUFF

MFG. MODEL NUMBER	DESCRIPTION	OPEN WEAVE ARAMID COVER W/ 30 OZ PRYME FLANNEL W/ MESH TOP	AIR BAG	PADDLE COVERS	CUFF CLAMPS COVER/PAD	TEXSTEEL STEEL BASE PAD
<b>AP1</b>	Single Buck	<b>ROWNF-1892 (RED)</b> —OR— <b>OWNF-1892 (NATURAL)</b>	<b>U-2310</b>	<b>2314 – Left</b>  <b>2316 – Right</b>	<b>2324*</b> <b>2312*</b> <b>2318 *</b> (See diagram on LA68)	<b>TS-1888</b>

\* Requires 2

MFG. MODEL NUMBER	Buck Size	DESCRIPTION	RED OPEN WEAVE ARAMID COVER	50 OZ BONN-E-BLUE PAD	TEXSTEEL STEEL BASE PAD
<b>AP1 (WCZ)</b> <b>Single Collar &amp; Cuff</b>	19 5/8 X 9 11 7/8 X 7	<b>Collar Cuffs (2)</b>	<b>ROWN-1185</b> <b>ROWN-1178</b>	<b>HB-1185</b> <b>HB-1178</b>	<b>TS-565**</b> <b>(Set of 3)</b>
<b>AP1 (QT4)</b> <b>Double Collar &amp; Cuff</b>	19 5/8 X 9 11 7/8 X 7	<b>Collar (2)</b> <b>Cuffs (4)</b>	<b>ROWN-1185</b> <b>ROWN-1178</b>	<b>HB-1185</b> <b>HB-1178</b>	<b>TS-565**</b> <b>(Set of 3)</b>

\*\*Spring pads must be removed prior to installation of Texsteel Steel Base Pads

### LIGHTNING AP2 CABINET AIR BAG BODY PRESS

MFG. MODEL NUMBER	DESCRIPTION	OPEN WEAVE ARAMID COVER W/ 30 OZ SPRYME FLANNEL W/ MESH TOP	AIR BAG	PADDLE COVERS	CUFF CLAMPS COVER/PAD	TEXSTEEL STEEL BASE PAD
<b>AP2</b>	Double Buck	<b>ROWNF-1892 (RED)</b> —OR— <b>OWNF-1892 (NATURAL)</b>	<b>U-2310</b>	<b>2314 – Left</b>  <b>2316 – Right</b>	<b>2324*</b> <b>2312*</b> <b>2318 *</b> (See diagram on LA68)	<b>TS-1888</b>

\* Requires 2



**UNIPRESS**

**THUNDER TS CABINET AIR BAG BODY PRESS**

MFG. MODEL NUMBER	DESCRIPTION	OPEN WEAVE ARAMID COVER W/ 30 OZ PRYME FLANNEL W/ MESH TOP	AIR BAG	TAIL CLAMP COVER	TAIL CLAMP TEXSTEEL STEEL BASE PAD	BODY TEXSTEEL STEEL BASE PAD
<b>TS1</b>	Single Buck	<b>ROWNF-2470 (RED)</b> -OR- <b>OWNF-2470 (NATURAL)</b>	<b>U-2485</b>	<b>2466</b>	<b>TS-2463</b>	<b>TS-2460</b>

**THUNDER TD2 CABINET AIR BAG BODY PRESS**

MFG. MODEL NUMBER	DESCRIPTION	OPEN WEAVE ARAMID COVER W/ 30 OZ PRYME FLANNEL W/ MESH TOP	AIR BAG	TAIL CLAMP COVER	TAIL CLAMP TEXSTEEL STEEL BASE PAD	BODY TEXSTEEL STEEL BASE PAD
<b>TD2</b>	Double Buck	<b>ROWNF-2470 (RED)</b> -OR- <b>OWNF-2470 (NATURAL)</b>	<b>U-2485</b>	<b>2466</b>	<b>TS-2463</b>	<b>TS-2460</b>



## UNIPRESS

### LIGHTNING NT CABINET AIR BAG BODY PRESS

MFG. MODEL NUMBER	DESCRIPTION	OPEN WEAVE COVER WITH 30 OZ. PRYME FLANNEL WITH MESH TOP		AIR BAG	NARROW AIR BAG	RED CUFF CLAMPS (See Diagram on LA 67)	TEXSTEEL STEEL BASE PAD
<b>Lightning NT</b>	Single Buck	<b>ROWNF-1892 (RED)</b>	<b>OWNF-1892 (NATURAL)</b>	<b>U-1888</b>	<b>U-2160</b>	<b>RAFM-1902 RAFM-1903 RAFM-1815* RAFM-1817*</b>	<b>TS-1888</b>

\* Requires 2

### LIGHTNING NT-1 CABINET AIR BAG BODY PRESS W/COLLAR & CUFF

MFG. MODEL NUMBER	DESCRIPTION	OPEN WEAVE COVER WITH 30 OZ. PRYME FLANNEL WITH MESH TOP		AIR BAG	NARROW AIR BAG	RED CUFF CLAMPS (See Diagram on LA 67)	TEXSTEEL STEEL BASE PAD
<b>Lightning NT-1 Cabinet Body Press</b>	Single Buck	<b>ROWNF-1892 (RED)</b>	<b>OWNF-1892 (NATURAL)</b>	<b>U-1888</b>	<b>U-2160</b>	<b>RAFM-1902 RAFM-1903 RAFM-1815* RAFM-1817*</b>	<b>TS-1888</b>

\* Requires 2

MFG. MODEL NUMBER	BUCK SIZE	DESCRIPTION	RED OPEN WEAVE ARAMID COVER/PAD	RED OPEN WEAVE ARAMID COVER	50 OZ. BONN-E-BLUE PAD	ARAMID SILICONE POCKET COVER*	SILICONE BASE PAD
<b>Lightning NT-1 Collar &amp; Cuff</b>	19 <sup>5</sup> / <sub>8</sub> x 9 13 <sup>1</sup> / <sub>4</sub> x 9 13 <sup>1</sup> / <sub>4</sub> x 9	Collar Left Cuff Right Cuff	<b>N/A URH-1976 URH-1977</b>	<b>ROWN-1185 N/A N/A</b>	<b>HB-1185 N/A N/A</b>	<b>BA-2094 BA-1982 BA-1983</b>	<b>CS-1896 (Set of 3)</b>

\* MUST BE USED WITH SILICONE PADDING.

### LIGHTNING NT-2 ROTARY CABINET AIR BAG BODY PRESS

MFG. MODEL NUMBER	DESCRIPTION	OPEN WEAVE COVER WITH 30 OZ. PRYME FLANNEL WITH MESH TOP		AIR BAG	NARROW AIR BAG	RED CUFF CLAMPS (See Diagram on LA 67)	TEXSTEEL STEEL BASE PAD
<b>Lightning NT-2</b>	Double Buck	<b>ROWNF-1892 (RED)</b>	<b>OWNF-1892 (NATURAL)</b>	<b>U-1888</b>	<b>U-2160</b>	<b>RAFM-1902 RAFM-1903 RAFM-1815* RAFM-1817*</b>	<b>TS-1888</b>

\* Requires 2



## UNIPRESS

### THUNDER SB-1 CABINET AIR BAG BODY PRESS

MFG. MODEL NUMBER	DESCRIPTION	COVER WITH 30 OZ. PRYME FLANNEL WITH MESH TOP		AIR BAG	NARROW AIR BAG	TEXSTEEL STEEL BASE PAD
<b>Thunder SB-1</b>	Single Buck	<b>ROWNF-1892 (RED)</b>	<b>OWNF-1892 (NATURAL)</b>	<b>U-1899</b>	<b>U-2156</b>	<b>TS-1888</b>

### THUNDER DB-2 CABINET AIR BAG BODY PRESS

MFG. MODEL NUMBER	DESCRIPTION	COVER WITH 30 OZ. PRYME FLANNEL WITH MESH TOP		AIR BAG	NARROW AIR BAG	TEXSTEEL STEEL BASE PAD
<b>Thunder DB-2</b>	Double Buck	<b>ROWNF-1892 (RED)</b>	<b>OWNF-1892 (NATURAL)</b>	<b>U-1899</b>	<b>U-2156</b>	<b>TS-1888</b>

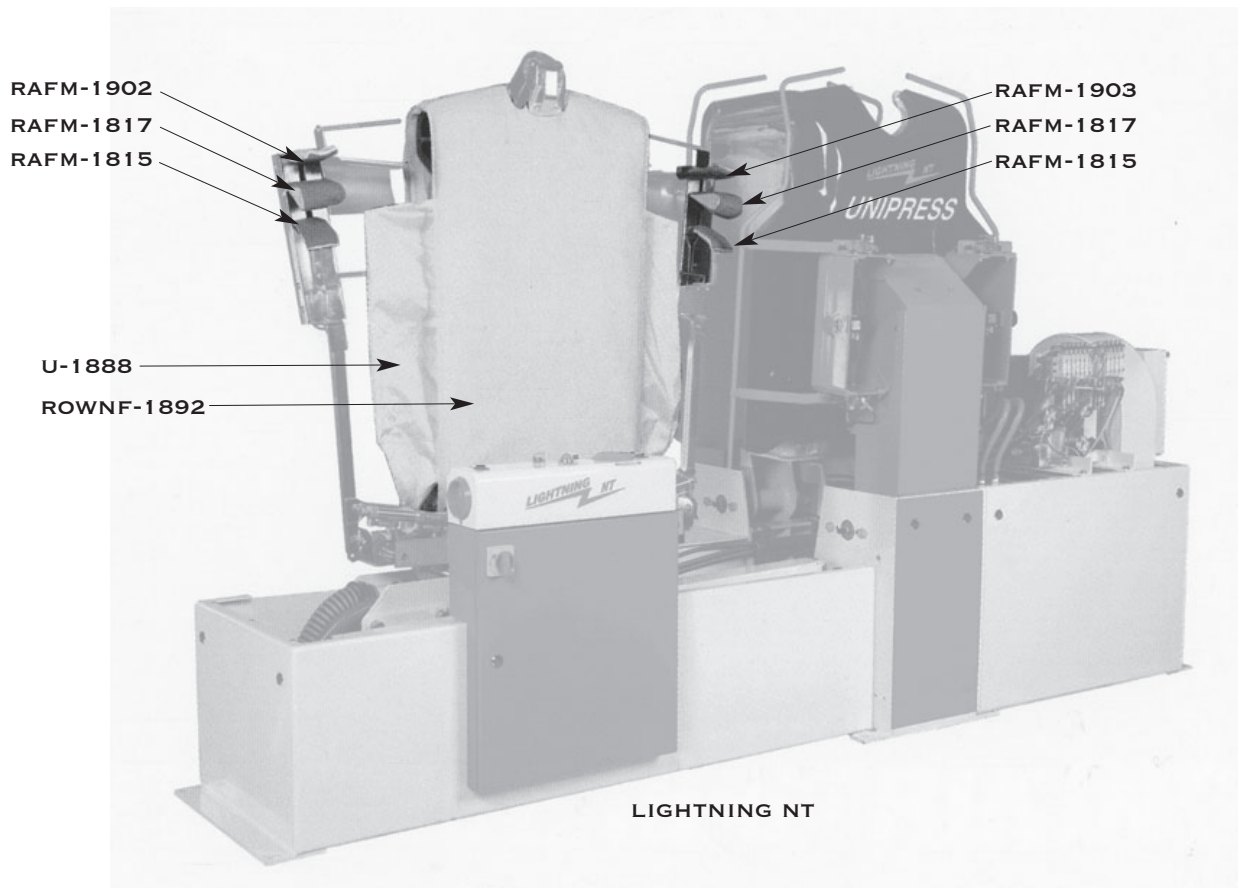

# LAUNDRY

## UNIPRESS CYCLONE CT CABINET AIR BAG BODY PRESS

MFG. MODEL NUMBER	DESCRIPTION	OPEN WEAVE ARAMID COVER W/ 30 OZ PRYME FLANNEL W/ MESH TOP	NARROW AIR BAG	LARGE AIR BAG	PADDLE COVERS	CUFF CLAMPS COVER/ PAD	TAIL CLAMP COVER PAD	TAIL CLAMP TEXSTEEL STEEL BASE PAD	BODY TEXSTEEL STEEL BASE PAD
<b>CT</b>	Single Buck	<b>ROWNF-3470 (RED)</b>	<b>U-2700</b>	<b>U-2725</b>	2314- Left  2316- Right	3324* 2073* 2704*	2478	CALL BUCKEYE	CALL BUCKEYE

\* REQUIRES 2

## UNIPRESS CYCLONE CT2/CT2H CABINET AIR BAG BODY PRESS

MFG. MODEL NUMBER	DESCRIPTION	OPEN WEAVE ARAMID COVER W/ 30 OZ PRYME FLANNEL W/ MESH TOP	NARROW AIR BAG	LARGE AIR BAG	PADDLE COVERS	CUFF CLAMPS COVER/ PAD	TAIL CLAMP COVER PAD	TAIL CLAMP TEXSTEEL STEEL BASE PAD	BODY TEXSTEEL STEEL BASE PAD
<b>CT2</b> <b>CT2H</b>	Double Buck	<b>ROWNF-3470 (RED)</b>	<b>U-2700</b>	<b>U-2725</b>	2314 - Left  2316 - Right	3324* 2073* 2704*	2478	CALL BUCKEYE	CALL BUCKEYE

\*REQUIRES 2





## UNIPRESS

### CABINET AIR BAG BODY PRESSES

MFG. MODEL NUMBER	DESCRIPTION	COVER WITH 30 OZ. PRYME FLANNEL WITH MESH TOP*		WIDE AIR BAG W/ MESH TOP	WIDE AIR BAG W/ MESH TOP (HEAVY DUTY)	TEXSTEEL STEEL BASE PAD
		OPEN WEAVE ARAMID	BON-DAC			
<b>SAYV</b>	Cabinet Single With Vacuum	<b>OWNF-1772</b>	<b>AF-1772</b>	<b>U-1771</b>	N/A	<b>TS-1773</b>
<b>DAYV</b>	Cabinet Double With Vacuum					
<b>VASY</b>	Combination Single Vacuum Body/Sleeve	<b>OWNF-1772</b>	<b>AF-1772</b>	<b>U-1773</b>	<b>U-1767</b>	<b>TS-1773</b>

\* Cover with 50 oz. Pryme Flannel available on request (OWNH-1772).

### VASY3 CABINET AIR BAG BODY PRESS W/COLLAR & CUFF

MFG. MODEL NUMBER	DESCRIPTION	COVER WITH 30 OZ. PRYME FLANNEL WITH MESH TOP*		WIDE AIR BAG W/ MESH TOP	WIDE AIR BAG W/ MESH TOP (HEAVY DUTY)	TEXSTEEL STEEL BASE PAD
		OPEN WEAVE ARAMID	BON-DAC			
<b>VASY3 Single Body</b>	All-in-one Shirt Press	<b>OWNF-1772</b>	<b>AF-1772</b>	<b>U-1773</b>	<b>U-1767</b>	<b>TS-1773</b>

\* Cover with 50 oz. Pryme Flannel available on request (OWNH-1772).

MFG. MODEL NUMBER	BUCK SIZE	DESCRIPTION	COMBO			COVERS		PADS	TEXSTEEL STEEL BASE PAD
			BONPAK NYLON COVER/PAD	BON-SPUN NYLON	HI-SPUN ARAMID	50 OZ. BONN-E-BLUE			
<b>VASY3 Collar &amp; Cuff</b>	19 5/8 x 9 12 x 7	Collar Cuffs (2)	<b>BP-1185</b> <b>BP-1178</b>	<b>B-1185</b> <b>B-1178</b>	<b>HS-1185</b> <b>HS-1178</b>	<b>HB-1185</b> <b>HB-1178</b>	<b>TS-565</b> (Set of 3)		

### VASY3P CABINET AIR BAG BODY PRESS W/COLLAR & CUFF

MFG. MODEL NUMBER	DESCRIPTION	COVER WITH 30 OZ. PRYME FLANNEL WITH MESH TOP*		WIDE AIR BAG W/ MESH TOP	WIDE AIR BAG W/ MESH TOP (HEAVY DUTY)	TEXSTEEL STEEL BASE PAD
		OPEN WEAVE ARAMID	BON-DAC			
<b>VASY3P Single Body</b>	All-in-one Shirt Press With Sleeve Pleater	<b>OWNF-1772</b>	<b>AF-1772</b>	<b>U-1773</b>	<b>U-1767</b>	<b>TS-1773</b>

\* Cover with 50 oz. Pryme Flannel available on request (OWNH-1772).

MFG. MODEL NUMBER	BUCK SIZE	DESCRIPTION	COMBO			COVERS		PADS	TEXSTEEL STEEL BASE PAD
			BONPAK NYLON COVER/PAD	BON-SPUN NYLON	HI-SPUN ARAMID	50 OZ. BONN-E-BLUE			
<b>VASY3P Collar &amp; Cuff</b>	19 5/8 x 9 12 x 11 x 7 12 x 11 x 7	Collar Pleat Cuff (Left) Pleat Cuff (Right)	<b>BP-1185</b> <b>BP-1193</b> <b>BP-1194</b>	<b>B-1185</b> <b>B-1193</b> <b>B-1194</b>	<b>HS-1185</b> <b>HS-1193</b> <b>HS-1194</b>	<b>HB-1185</b> <b>HB-1193</b> <b>HB-1194</b>	<b>TS-566</b> (Set of 3)		



## UNIPRESS

### CABINET AIR BAG BODY PRESSES W/ COLLAR & CUFF

MFG. MODEL NUMBER	DESCRIPTION	COVER WITH 30 OZ. PRYME FLANNEL WITH MESH TOP*		WIDE AIR BAG W/ MESH TOP	WIDE AIR BAG W/ MESH TOP (HEAVY DUTY)	CUFF CLAMPS	TEXSTEEL STEEL BASE PAD
		OPEN WEAVE ARAMID	BON-DAC				
<b>VASY3P-C Single Body</b>	All-in-one Shirt Press with Sleeve Pleater & Cuff Clamp	<b>OWNF-1772</b>	<b>AF-1772</b>	<b>U-1773</b>	<b>U-1767</b>	<b>BAFM-1811 BAFM-1813 BAFM-1815** BAFM-1817**</b>	<b>TS-1773</b>

\* Cover with 50 oz. Pryme Flannel available on request (OWNH-1772).

\*\* Requires 2

MFG. MODEL NUMBER	BUCK SIZE	DESCRIPTION	COMBO		COVERS		PADS	
			BONPAK NYLON COVER/PAD		BON-SPUN NYLON	HI-SPUN ARAMID	50 OZ. BONN-E-BLUE	TEXSTEEL STEEL BASE PAD*
<b>VASY3P-C Single Collar/Cuff</b>	19 5/8 x 9	Collar	<b>BP-1185</b>		<b>B-1185</b>	<b>HS-1185</b>	<b>HB-1185</b>	<b>TS-566</b>
	12 x 11 x 7	Pleat Cuff (Left)	<b>BP-1193</b>		<b>B-1193</b>	<b>HS-1193</b>	<b>HB-1193</b>	<b>(Set of 3)</b>
	12 x 11 x 7	Pleat Cuff (Right)	<b>BP-1194</b>		<b>B-1194</b>	<b>HS-1194</b>	<b>HB-1194</b>	



**CRD-C**



**OWNF-1772 —  
COVER W/30 OZ.  
PRYME FLANNEL  
W/MESH TOP**

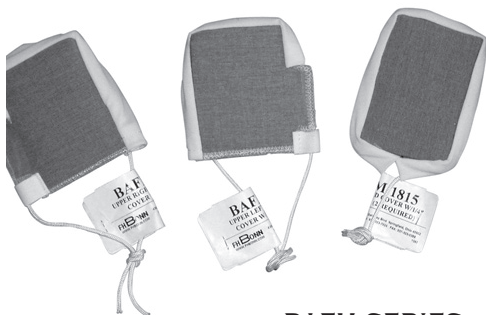

**BAFM SERIES**



**TS-1713 —  
TEXSTEEL  
STEEL BASE  
PAD**

REPLACING WORN  
TEXSTEEL  
ELIMINATES  
BROKEN BUTTONS &  
UNNECESSARY PAD  
AND COVER WEAR

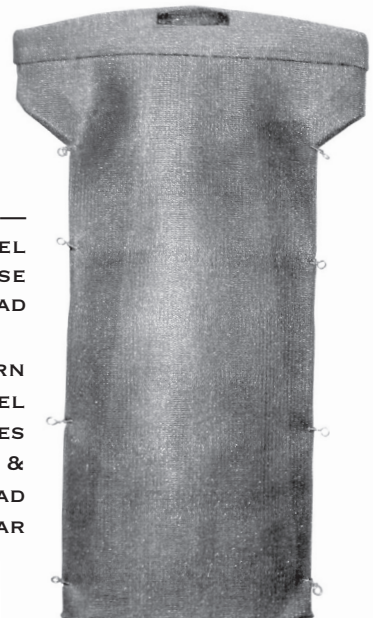

# LAUNDRY



## UNIPRESS

### CABINET AIR BAG BODY PRESSES

MFG. MODEL NUMBER	DESCRIPTION	COVER WITH 30 OZ. PRYME FLANNEL WITH MESH TOP*		WIDE AIR BAG W/ MESH TOP	WIDE AIR BAG W/ MESHTOP (HEAVY DUTY)	CUFF CLAMPS	TEXSTEEL STEEL BASE PAD
		OPEN WEAVE ARAMID	BON-DAC				
<b>CRS</b>	Combination Rotary Single Buck	<b>OWNF-1772</b>	<b>AF-1772</b>	<b>U-1773</b>	<b>U-1767</b>	<b>N/A</b>	<b>TS-1773</b>
<b>CRD</b>	Combination Rotary Double Buck						
<b>CRS-C</b>	Combination Rotary Single Buck w/Cuff Clamps	<b>OWNF-1772</b>	<b>AF-1772</b>	<b>U-1773</b>	<b>U-1767</b>	<b>BAFM-1811 BAFM-1813 BAFM-1815** BAFM-1817**</b>	<b>TS-1773</b>
<b>CRD-C</b>	Combination Rotary Double Buck w/Cuff Clamps						
<b>USCS</b>	Combination Single Vacuum Body/ Sleeve	<b>OWNF-1765</b>	<b>AF-1765</b>	<b>U-1775</b>	<b>N/A</b>	<b>N/A</b>	<b>TS-1775</b>
<b>UDC</b>	Combination Double Vacuum Body/ Sleeve						

\* Cover with 50 oz. Pryme Flannel available on request (OWNH-1772).

\*\* Requires 2

MFG. MODEL NUMBER	DESCRIPTION	COVERS			PADS			TEXSTEEL STEEL BASE PAD
		OPEN WEAVE ARAMID W/WIDE OUTER COVER	BON-DAC OUTER COVER	ARAMID OUTER COVER	WIDE 30 OZ. PRYME FLANNEL	WIDE AIR BAG W/ MESH TOP		
<b>SBT</b>	Cabinet Single Shirt Press	<b>OWN-1761</b>	<b>A-1761</b>	<b>HS-1761</b>	<b>F-1761</b>	<b>U-1771</b>	<b>TS-1761</b>	
<b>DBT</b>	Cabinet Double Shirt Press							

MFG. MODEL NUMBER	DESCRIPTION	COVERS		PADS		AIRBAGS			TEXSTEEL STEEL BASE PAD
		BON-DAC OUTER COVER	ARAMID OUTER COVER	21 OZ. PRYME*	30 OZ. PRYME	INSIDE COVER W/AIR BAGS	INSIDE COVER W/LARGER AIR BAGS	DELUXE ARAMID INSULATION BOOT**	
<b>CSB</b>	Compact Single	<b>A-1318</b>	<b>HS-1318</b>	<b>D-1318</b>	<b>F-1318</b>	<b>U-1317</b>	<b>U-1652</b>	<b>K-1317</b>	<b>TS-1317</b>
<b>CDB</b>	Compact Double								

\* To be used over new steel pads.

\*\* Boot is included with FLAN-O-WOOL Pads.

# LAUNDRY



## UNIPRESS CABINET AIR BAG BODY PRESSES

MFG. MODEL NUMBER	BUCK DESCRIPTION	COVERS			PADS		INSIDE COVER W/AIR BAGS STANDARD	INSIDE COVER W/LARGER AIR BAGS	TEXSTEEL STEEL BASE PAD
		OPENWEAVE ARAMID OUTER COVER	BON-DAC OUTER COVER	ARAMID OUTER COVER	30 OZ. PRYME	21 OZ. PRYME*			
<b>CSB-V Single Shirt</b> <b>CDB-V Double Shirt</b>	Compact Vacuum	OWN-1318	A-1318	HS-1318	F-1661	D-1661	U-1317	U-1652	TS-1713
<b>UDB-V Double Shirt</b>	Vacuum Press								
<b>CSF-V Single Shirt</b>	Compact Vacuum	OWN-1318	A-1318	HS-1318	F-1318	D-1318	OWPA-1713	OWPA-1733	TS-1713

\* To be used over new steel pads.

## UNIPRESS CABINET AIR BAG BODY PRESSES W/COLLAR & CUFF

MFG. MODEL NUMBER	DESCRIPTION	COVERS			PADS			TEXSTEEL STEEL BASE PAD
		OPENWEAVE ARAMID OUTER COVER	BON-DAC OUTER COVER	ARAMID OUTER COVER	21 OZ. PRYME*	30 OZ. PRYME	COVER W/AIR BAGS	
<b>CSF-V3 Single Shirt</b>	Compact Vacuum	OWN-1318	A-1318	HS-1318	D-1318*	F-1318	OWPA-1713	TS-1713

\* To be used over new steel pads.

MFG. MODEL NUMBER	BUCK SIZE	DESCRIPTION	COMBO BONPAK NYLON COVER/PAD	COVERS		PADS 50 OZ. BONN-E-BLUE	TEXSTEEL STEEL BASE PAD
				BON-SPUN NYLON	HI-SPUN ARAMID		
<b>CSF-V3 Collar/Cuff</b>	19 5/8 x 9 11 7/8 x 7	Collar Cuffs (2)	BP-1185 BP-1178	B-1185 B-1178	HS-1185 HS-1178	HB-1185 HB-1178	TS-565 (Set of 3)

MFG. MODEL NUMBER	DESCRIPTION	COVERS			PADS		TEXSTEEL STEEL BASE PAD	
		OPENWEAVE ARAMID OUTER COVER	BON-DAC OUTER COVER	ARAMID OUTER COVER	21 OZ. PRYME*	30 OZ. PRYME		
<b>CSF-V3P Single Shirt</b>	All-in-one with Sleeve Pleater	OWN-1318	A-1318	HS-1318	D-1318*	F-1318	OWPA-1713	TS-1713

\* To be used over new steel pads.

MFG. MODEL NUMBER	BUCK SIZE	DESCRIPTION	COMBO BONPAK NYLON COVER/PAD	COVERS		PADS 50 OZ. BONN-E-BLUE	TEXSTEEL STEEL BASE PAD
				BON-SPUN NYLON	HI-SPUN ARAMID		
<b>CSF-V3P Collar/Cuff</b>	19 5/8 x 9 12 x 11 x 7 12 x 11 x 7	Collar Pleat Cuff (Left) Pleat Cuff (Right)	BP-1185 BP-1193 BP-1194	B-1185 B-1193 B-1194	HS-1185 HS-1193 HS-1194	HB-1185 HB-1193 HB-1194	TS-566 (Set of 3)

LA 76

CALL OR EMAIL US WITH ANY QUESTIONS  
937-462-5148 CUSTOMERSERVICE@FHBONN.COM



## UNIPRESS

### CABINET AIR BAG BODY PRESSES

MFG. MODEL NUMBER	BUCK DESCRIPTION	WHITE KNIT OUTER COVER W/30 OZ. DFN PAD ATTACHED	INSIDE COVER W/AIR BAGS		TEXSTEEL STEEL BASE PAD
<b>RTB Extender Arms</b>	Rotomatic Triple	<b>WKF-1660</b>	<b>AH-1659</b>		<b>TS-1659</b>
<b>RTB II No Extender Arms</b>	Rotomatic Triple	<b>WKF-1660</b>	<b>AH-1814</b> (Regular Duty)	<b>AH-1854</b> (Heavy Duty)	<b>TS-1659</b>
<b>RTB III RTB V</b>	Rotomatic Triple	<b>WKF-1806</b>	<b>U-1810</b> (Regular Duty)	<b>U-1874</b> (Heavy Duty)	<b>TS-1659</b>

### CABINET AIR BAG SLEEVERS

MFG. MODEL NUMBER	DESCRIPTION	LEFT HAND BAG COVER W/FLANNEL BUILD-UP	RIGHT HAND BAG COVER W/FLANNEL BUILD-UP	AIR BAGS	PF BLADE COVERS
<b>ABS Standard</b>	Air Bag Sleever	<b>1362D</b>	<b>1363D</b>	<b>1361*</b>	<b>C-1328*</b>
<b>ABS Oversized</b>	Air Bag Sleever	<b>1601D</b>	<b>1602D</b>	<b>1600*</b>	<b>C-1328*</b>
<b>ABS Standard Aramid</b>	Air Bag Sleever	<b>HT-1362D</b>	<b>HT-1363D</b>	<b>1361*</b>	<b>C-1328*</b>
<b>ABS Oversized Aramid</b>	Air Bag Sleever	<b>HT-1601D</b>	<b>HT-1602D</b>	<b>1600*</b>	<b>C-1328*</b>
<b>UCS</b>	Air Bag Sleever	<b>1697D</b>	<b>1698D</b>	<b>1696*</b>	<b>C-1328*</b>

\* Requires 2



ABS



RTB II



## UNIPRESS CABINET AIR BAG BODY PASSES

MFG. MODEL NUMBER	DESCRIPTION	ROD SLEEVE TYPE COVERS			TIE-ON TYPE COVERS		FLANNEL PADS			HI-SPUN INSULATION BOOT	TEXSTEEL STEEL BASE PAD
		BON-SPUN NYLON	BON-TWILL	HI-SPUN ARAMID	BON-TWILL COVER W/30 OZ. DFN PAD	BON-TWILL COVER ONLY	30 OZ. PRYME	30 OZ. BONN-E-BLUE	50 OZ. BONN-E-BLUE		
<b>BAS-A</b>	SINGLE	<b>B-400</b>	<b>N/A</b>	<b>HS-400</b>	<b>N/A</b>	<b>N/A</b>	<b>F-400</b>	<b>N/A</b>	<b>HB-400</b>	<b>J-400</b>	<b>TS-400</b>
<b>BASE-A</b>	SINGLE	<b>B-367</b>	<b>L-367</b>	<b>HS-367</b>	<b>LF-776</b>	<b>L-776</b>	<b>F-367</b>	<b>FB-367</b>	<b>HB-367</b>	<b>J-367</b>	<b>TS-367</b>
<b>BASF-A*</b>	SINGLE	<b>B-371</b>	<b>L-371</b>	<b>HS-371</b>	<b>LF-767</b>	<b>L-767</b>	<b>F-371</b>	<b>FB-371</b>	<b>HB-371</b>	<b>J-371</b>	<b>TS-371</b>
<b>BAY-D</b>	SINGLE	<b>B-400</b>	<b>N/A</b>	<b>HS-400</b>	<b>N/A</b>	<b>N/A</b>	<b>F-400</b>	<b>N/A</b>	<b>HB-400</b>	<b>J-400</b>	<b>TS-400</b>
<b>BAY-E</b>	SINGLE	<b>B-367</b>	<b>L-367</b>	<b>HS-367</b>	<b>LF-776</b>	<b>L-776</b>	<b>F-367</b>	<b>FB-367</b>	<b>HB-367</b>	<b>J-367</b>	<b>TS-367</b>
<b>DBASE-A</b>	DOUBLE	<b>B-367</b>	<b>L-367</b>	<b>HS-367</b>	<b>LF-776</b>	<b>L-776</b>	<b>F-367</b>	<b>FB-367</b>	<b>HB-367</b>	<b>J-367</b>	<b>TS-367</b>
<b>DBASF-A*</b>	DOUBLE	<b>B-371</b>	<b>L-371</b>	<b>HS-371</b>	<b>LF-767</b>	<b>L-767</b>	<b>F-371</b>	<b>FB-371</b>	<b>HB-371</b>	<b>J-371</b>	<b>TS-371</b>
<b>DBAY-E</b>	DOUBLE	<b>B-367</b>	<b>L-367</b>	<b>HS-367</b>	<b>LF-776</b>	<b>L-776</b>	<b>F-367</b>	<b>FB-367</b>	<b>HB-367</b>	<b>J-367</b>	<b>TS-367</b>

### EXPANDERS FOR ABOVE PASSES

EXPANDER DESCRIPTION	UNI-DAC COVER	30 OZ. BONN-E-BLUE PAD
Split Wing*	<b>M-397**</b>	<b>FB-397**</b>
Solid Wing	<b>M-398**</b>	<b>FB-398**</b>

\* The **BASF-A** and **DBASF-A** models always have the split wing type expander.

\*\* Requires 2

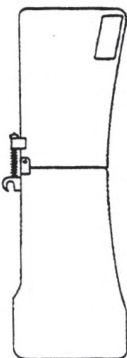

**BASF-A  
DBASF-A  
AND ALL  
MODELS WITH  
SPLIT WINGS  
#397**

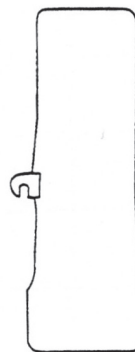

**SOLID  
WING  
#398**

# LAUNDRY



## UNIPRESS CABINET SLEEVERS

		COVER/PADS			
MFG. MODEL NUMBER	DESCRIPTION	POLYESTER COVER W/21 OZ. DFN	POLYESTER COVER W/30 OZ. DFN	BON-TWILL COVER W/21 OZ. DFN	TEXSTEEL STEEL BASE PAD W/PAD HOLDERS (SET OF 2)
<b>MSA</b>	Ty On Covers	<b>CPDB-130*</b>	<b>CPFB-130*</b>	<b>LD-130*</b>	<b>Set TS-130</b>
<b>MSA</b>	Slip On Covers	<b>CPDB-481*</b>	<b>CPFB-481*</b>	<b>N/A</b>	<b>Set TS-130</b>
<b>SA</b>	Ty On Covers	<b>CPDB-116*</b>	<b>N/A</b>	<b>N/A</b>	<b>Set TS-116</b>

\* Requires 2

## EXPANDERS FOR ABOVE PRESSES (SEE DIAGRAMS BELOW)

MFG. MODEL NUMBER	EXPANDER DESCRIPTION	NYLON COVER	20 OZ. BONN-E-BLUE NYLON PAD
<b>MSA</b>	Current Style	<b>M-161*</b>	<b>DB-161*</b>
<b>MSA</b>	With Lock Rod	<b>M-144*</b>	<b>DB-144*</b>
<b>MSA</b>	No Lock Rod	<b>M-143*</b>	<b>DB-143*</b>
<b>MSA</b>	Original	<b>M-129*</b>	<b>DB-129*</b>
<b>SA</b>		<b>M-114*</b>	<b>DB-114*</b>

\* Requires 2



#161



#144



#143

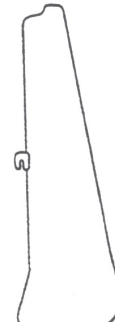

#129

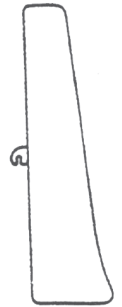

#114

## MINIMATIC SLEEVERS

MFG. MODEL NUMBER	DESCRIPTION	FIL-DAC AIR BAGS	AIR RETENTION BOOTS	HI-SPUN ARAMID COVER W/DFN PAD (GUSSET)	TEXSTEEL STEEL BASE PAD (Set of 2)
<b>EMS-2</b> (Electric)	Gusset Sleever	<b>N/R</b>	<b>M-1377*</b>	<b>HTD-6*</b>	<b>Set TS-6</b>
<b>MS-2</b>	Gusset Sleever	<b>N/R</b>	<b>M-1377*</b>	<b>HTD-6*</b>	<b>Set TS-6</b>
<b>AF-3</b>	Air Bag Sleever After Serial # 8465070	<b>FD-1182*</b>	<b>N/R</b>	<b>HTD-6*</b>	<b>Set TS-6</b>
<b>AF-3</b>	Prior to Serial # 8465070	<b>FD-1180*</b>	<b>N/R</b>	<b>HTD-6*</b>	<b>Set TS-6</b>
<b>EAF-3</b>	Air Bag Sleever After Serial # 8465070 (Electric)	<b>FD-1182*</b>	<b>N/R</b>	<b>HTD-6*</b>	<b>Set TS-6</b>

\* Requires 2

# LAUNDRY



## UNIPRESS FLATBED PRESSES

MFG. MODEL NUMBER	BUCK SIZE	DESCRIPTION	COMBO		COVERS		PADS	TEXSTEEL STEEL BASE PAD*
			BONPAK NYLON COVER/ PAD	BON-SPUN NYLON	HI-SPUN ARAMID	50 OZ. BONN-E- BLUE		
<b>BB</b>	40 x 17	Body Bosom	<b>BP-208</b>	<b>B-208</b>	<b>HS-208</b>	<b>HB-208</b>	<b>TS-443</b>	
<b>BCCY</b>	17 x 7 1/2 11 x 6	Boys Collar/Yoke Cuff	<b>BP-1173</b> <b>BP-1176</b>	<b>B-1173</b> <b>B-1176</b>	<b>HS-1173</b> <b>HS-1176</b>	<b>HB-1173</b> <b>HB-1176</b>	<b>TS-445</b> (Set of 2)	
<b>BCCY-A</b>	17 x 7 1/2 12 x 7	Boys Collar/Yoke Cuff	<b>BP-39</b> <b>BP-23</b>	<b>B-39</b> <b>B-23</b>	<b>HS-39</b> <b>HS-23</b>	<b>HB-39</b> <b>HB-23</b>	<b>TS-446</b> (Set of 2)	
<b>BSTH</b>	19 x 7 12 x 7	Boys Collar Cuffs (2)	<b>BP-1179</b> <b>BP-1176</b>	<b>B-1179</b> <b>B-1176</b>	<b>HS-1179</b> <b>HS-1176</b>	<b>HB-1179</b> <b>HB-1176</b>	<b>TS-448</b> (Set of 3)	
<b>BT-B</b>	40 x 17	Body Bosom	<b>BP-205</b>	<b>B-205</b>	<b>HS-205</b>	<b>HB-205</b>	<b>TS-449</b>	
<b>CCC</b>	18 x 7 11 x 7	Collar Cuffs (2)	<b>BP-72**</b> <b>BP-20**</b>	<b>B-72**</b> <b>B-20**</b>	<b>HS-72**</b> <b>HS-20**</b>	<b>HB-72</b> <b>HB-20</b>	<b>TS-451</b> (Set of 3)	
<b>CCV</b>	38 3/4 x 7 1/4	Collar and Cuff w/Vacuum (Electric)	<b>BA-1835 Blue Aramid Cover</b> <b>M-1807 Silicone Pad</b>					<b>N/A</b>
<b>CCY</b>	21 x 11 12 x 7	Collar/Yoke Cuff	<b>BP-1175</b> <b>BP-1178</b>	<b>B-1175</b> <b>B-1178</b>	<b>HS-1175</b> <b>HS-1178</b>	<b>HB-1175</b> <b>HB-1178</b>	<b>TS-452</b> (Set of 2)	
<b>CCY-W</b>	21 x 8 12 x 7	Collar/Yoke Cuff	<b>BP-1680</b> <b>BP-1178</b>	<b>B-1680</b> <b>B-1178</b>	<b>HS-1680</b> <b>HS-1178</b>	<b>HB-1680</b> <b>HB-1178</b>	<b>TS-558</b> (Set of 2)	
<b>CSF-V3</b>	19 5/8 x 9 12 x 7	Collar/Yoke Cuffs (2)	<b>BP-1185</b> <b>BP-1178</b>	<b>B-1185</b> <b>B-1178</b>	<b>HS-1185</b> <b>HS-1178</b>	<b>HB-1185</b> <b>HB-1178</b>	<b>TS-565</b> (Set of 3)	
<b>CSF-V3P</b>	19 5/8 x 9 12 x 11 x 7 12 x 11 x 7	Collar/Yoke Cuff (Left) Cuff (Right)	<b>BP-1185</b> <b>BP-1193</b> <b>BP-1194</b>	<b>B-1185</b> <b>B-1193</b> <b>B-1194</b>	<b>HS-1185</b> <b>HS-1193</b> <b>HS-1194</b>	<b>HB-1185</b> <b>HB-1193</b> <b>HB-1194</b>	<b>TS-566</b> (Set of 3)	
<b>DCCL-A</b>	27 x 10 x 6 12 x 7	Collar/Lapel Cuffs (2)	<b>BP-152</b> <b>BP-20</b>	<b>B-152</b> <b>B-20</b>	<b>HS-152</b> <b>HS-20</b>	<b>HB-152</b> <b>HB-20</b>	<b>TS-454</b> (Set of 3)	
<b>DCL-A</b>	12 x 7	Double Cuffs (2)	<b>BP-23</b>	<b>B-23</b>	<b>HS-23</b>	<b>HB-23</b>	<b>TS-455</b> (Set of 2)	
<b>DLZ</b>	42 x 24	Rectangular	<b>BP-213</b>	<b>B-213</b>	<b>HS-213</b>	<b>HB-213</b>	<b>TS-514</b>	
<b>DS-A</b>	22 x 11	Double Rectangular (2)	<b>BP-86</b>	<b>B-86</b>	<b>HS-86</b>	<b>HB-86</b>	<b>TS-456</b> (Set of 2)	

\*\* For Skirted  
Tie-On Covers  
order the following:  
Collar 89  
Cuffs (2) 24

\* SPECIFY BARE BUCK  
or OVER SPRINGS

# LAUNDRY



## UNIPRESS FLATBED PRESSES

MFG. MODEL NUMBER	BUCK SIZE	DESCRIPTION	COMBO	COVERS		PADS	
			BONPAK NYLON COVER/ PAD	BON-SPUN NYLON	HI-SPUN ARAMID	50 OZ. BONN-E- BLUE	TEXSTEEL STEEL BASE PAD*
<b>DS-B</b>	22 x 11	Rectangular	<b>BP-86</b>	<b>B-86</b>	<b>HS-86</b>	<b>HB-86</b>	<b>TS-457</b>
<b>DSE-A</b>	12 x 10 x 9 <sup>3</sup> / <sub>4</sub> - Left 12 x 10 x 9 <sup>3</sup> / <sub>4</sub> - Right	Double Sleever	<b>BP-21</b> <b>BP-22</b>	<b>B-21</b> <b>B-22</b>	<b>HS-21</b> <b>HS-22</b>	<b>HB-21</b> <b>HB-22</b>	<b>TS-458</b> (Set of 2)
<b>DSEW-A</b>	12 x 10 x 9 <sup>3</sup> / <sub>4</sub> - Left 21 x 20 x 11 - Right	Double Sleever	<b>BP-21</b> <b>BP-113</b>	<b>B-21</b> <b>B-113</b>	<b>HS-21</b> <b>HS-113</b>	<b>HB-21</b> <b>HB-113</b>	<b>TS-459</b> (Set of 2)
<b>DSL-A</b>	21 x 18 x 10 - Left 21 x 18 x 10 - Right	Double Sleever	<b>BP-91</b> <b>BP-92</b>	<b>B-91</b> <b>B-92</b>	<b>HS-91</b> <b>HS-92</b>	<b>HB-91</b> <b>HB-92</b>	<b>TS-460</b> (Set of 2)
<b>DTZ</b>	36 x 12	Double End Pants Topper	<b>BP-184</b>	<b>B-184</b>	<b>HS-184</b>	<b>HB-184</b>	<b>TS-531</b>
<b>EBB-A</b>	32 <sup>1</sup> / <sub>2</sub> x 16 x 13 <sup>1</sup> / <sub>2</sub>	Body Bosom (Electric)	<b>N/A</b>	<b>N/A</b>	<b>HS-174</b>	<b>HB-174</b>	<b>TS-461</b>
<b>EBCCY</b>	20 x 9 x 7 x 6 12 x 7	Boy's Collar/Yoke Cuff (Electric)	<b>N/A</b> <b>N/A</b>	<b>N/A</b> <b>N/A</b>	<b>HS-1173</b> <b>HS-1176</b>	<b>HB-1173</b> <b>HB-1176</b>	<b>TS-462</b> (Set of 2)
<b>ECCY</b>	21 x 11 12 x 7	Collar/Yoke Cuff (Electric)	<b>N/A</b> <b>N/A</b>	<b>N/A</b> <b>N/A</b>	<b>HS-1175</b> <b>HS-1178</b>	<b>HB-1175</b> <b>HB-1178</b>	<b>TS-463</b> (Set of 2)
<b>ECCY-A</b>	20 x 9 x 7 12 x 7	Collar/Yoke Cuff (Electric)	<b>N/A</b> <b>N/A</b>	<b>N/A</b> <b>N/A</b>	<b>HS-122</b> <b>HS-23</b>	<b>HB-122</b> <b>HB-23</b>	<b>TS-464</b> (Set of 2)
<b>ECCY-W</b>	21 x 8 12 x 7	Collar/Yoke Cuff (Electric)	<b>N/A</b> <b>N/A</b>	<b>N/A</b> <b>N/A</b>	<b>HS-1680</b> <b>HS-1178</b>	<b>HB-1680</b> <b>HB-1178</b>	<b>TS-559</b> (Set of 2)
<b>EFB</b>	30 x 13 x 10	Body Bosom (Electric)	<b>N/A</b>	<b>N/A</b>	<b>HS-166</b>	<b>HB-166</b>	<b>TS-504</b>
<b>EFTP</b>	19 x 10	Oval Mushroom (Electric)	<b>N/A</b>	<b>N/A</b>	<b>HS-51</b>	<b>HB-51</b>	<b>TS-605</b>
<b>ESLZ</b>	53 <sup>1</sup> / <sub>2</sub> x 19 x 11	Tapered (Electric)	<b>N/A</b>	<b>N/A</b>	<b>HS-258</b>	<b>HB-258</b>	<b>TS-579</b>
<b>FB</b>	30 x 13 x 10	Body Bosom	<b>BP-166</b>	<b>B-166</b>	<b>HS-166</b>	<b>HB-166</b>	<b>TS-503</b>
<b>FMT</b>	20 x 10	Oval Mushroom	<b>BP-67</b>	<b>B-67</b>	<b>HS-67</b>	<b>HB-67</b>	<b>TS-526</b>
<b>FTP</b>	19 x 10	Oval Mushroom	<b>BP-51</b>	<b>B-51</b>	<b>HS-51</b>	<b>HB-51</b>	<b>TS-525</b>

\* SPECIFY BARE BUCK  
or OVER SPRINGS

# LAUNDRY



## UNIPRESS FLATBED PRESSES

			COMBO	COVERS		PADS	
MFG. MODEL NUMBER	BUCK SIZE	DESCRIPTION	BONPAK NYLON COVER/PAD	BON-SPUN NYLON	HI-SPUN ARAMID	50 OZ. BONN-E-BLUE	TEXSTEEL STEEL BASE PAD*
<b>LPZ</b>	53 x 18½	Rectangular	<b>BP-254</b>	<b>B-254</b>	<b>HS-254</b>	<b>HB-254</b>	<b>TS-578</b>
<b>LSTH-S</b>	19½ x 8 12 x 7	Collar Cuffs (2)	<b>BP-72**</b> <b>BP-20**</b>	<b>B-72**</b> <b>B-20**</b>	<b>HS-72**</b> <b>HS-20**</b>	<b>HB-72</b> <b>HB-20</b>	<b>TS-465</b> (Set of 3)

MFG. MODEL NUMBER	BUCK SIZE	DESCRIPTION	RED OPEN WEAVE ARAMID COVER/PAD	RED OPEN WEAVE ARAMID COVER	50 OZ. BONN-E-BLUE PAD	ARAMID SILICONE POCKET COVER*	SILICONE BASE PAD
<b>PCF</b>	19 x 7 13¼ x 9 13¼ x 9	Collar Left Cuff Right Cuff	<b>N/A</b> <b>URH-1976</b> <b>URH-1977</b>	<b>ROWN-1179</b> <b>N/A</b> <b>N/A</b>	<b>HB-1179</b> <b>N/A</b> <b>N/A</b>	<b>BA-2092</b> <b>BA-1982</b> <b>BA-1983</b>	<b>CS-1889</b> (Set of 3)
<b>PCZ</b>	19⅝ x 9 13¼ x 9 13¼ x 9	Collar Left Cuff Right Cuff	<b>N/A</b> <b>URH-1976</b> <b>URH-1977</b>	<b>ROWN-1185</b> <b>N/A</b> <b>N/A</b>	<b>HB-1185</b> <b>N/A</b> <b>N/A</b>	<b>BA-2094</b> <b>BA-1982</b> <b>BA-1983</b>	<b>CS-1896</b> (Set of 3)

\* **MUST BE USED WITH SILICONE PADDING.**

			COMBO	COVERS		PADS	
MFG. MODEL NUMBER	BUCK SIZE	DESCRIPTION	BONPAK NYLON COVER/PAD	BON-SPUN NYLON	HI-SPUN ARAMID	50 OZ. BONN-E-BLUE	TEXSTEEL STEEL BASE PAD*
<b>SBT-A</b>	40 x 17	Body Bosom	<b>BP-205</b>	<b>B-205</b>	<b>HS-205</b>	<b>HB-205</b>	<b>TS-467</b>
<b>SCCY</b>	18 x 9 x 7 12 x 7	Collar/Yoke Cuffs (2)	<b>BP-1175</b> <b>BP-1178</b>	<b>B-1175</b> <b>B-1178</b>	<b>HS-1175</b> <b>HS-1178</b>	<b>HB-1175</b> <b>HB-1178</b>	<b>TS-468</b> (Set of 3)
<b>SCCY-A</b>	20 x 9½ 13 x 7	Collar/Yoke Cuffs (2)	<b>BP-56</b> <b>BP-23</b>	<b>B-56</b> <b>B-23</b>	<b>HS-56</b> <b>HS-23</b>	<b>HB-56</b> <b>HB-23</b>	<b>TS-469</b> (Set of 3)
<b>SCCY-B</b>	20 x 11 13 x 7	Collar/Yoke Cuffs (2)	<b>BP-56</b> <b>BP-23</b>	<b>B-56</b> <b>B-23</b>	<b>HS-56</b> <b>HS-23</b>	<b>HB-56</b> <b>HB-23</b>	<b>TS-470</b> (Set of 3)
<b>SCCY-G-A</b>	20 x 9½ 10 x 10	Collar/Yoke Gusset Cuffs (2)	<b>BP-56</b> <b>BP-12</b>	<b>B-56</b> <b>B-12</b>	<b>HS-56</b> <b>HS-12</b>	<b>HB-56</b> <b>HB-12</b>	<b>TS-471</b> (Set of 3)

\*\* For Skirted Tie On Covers order the following Bonnco code:

Collar	89
Cuffs (2)	24

\* SPECIFY BARE BUCK or OVER SPRINGS

# LAUNDRY



## UNIPRESS FLATBED PRESSES

MFG. MODEL NUMBER	BUCK SIZE	DESCRIPTION	COMBO		COVERS		PADS	TEXSTEEL STEEL BASE PAD*
			BONPAK NYLON COVER/ PAD	BON-SPUN NYLON	HI-SPUN ARAMID	50 OZ. BONN-E- BLUE		
<b>SCCY-G-B</b>	20 x 9 1/2 10 x 10	Collar/Yoke Gusset Cuffs (2)	<b>BP-56</b> <b>BP-12</b>	<b>B-56</b> <b>B-12</b>	<b>HS-56</b> <b>HS-12</b>	<b>HB-56</b> <b>HB-12</b>	<b>TS-472</b> (Set of 3)	
<b>SLZ</b>	53 1/2 x 19 x 11	Tapered	<b>BP-258</b>	<b>B-258</b>	<b>HS-258</b>	<b>HB-258</b>	<b>TS-517</b>	
<b>STH</b>	19 1/2 x 7 12 x 7	Collar Cuffs (2)	<b>BP-72**</b> <b>BP-20**</b>	<b>B-72**</b> <b>B-20**</b>	<b>HS-72**</b> <b>HS-20**</b>	<b>HB-72</b> <b>HB-20</b>	<b>TS-473</b> (Set of 3)	
<b>STH-A</b>	21 x 8 12 x 7	Collar Cuffs (2)	<b>BP-81**</b> <b>BP-23**</b>	<b>B-81**</b> <b>B-23**</b>	<b>HS-81**</b> <b>HS-23**</b>	<b>HB-81</b> <b>HB-23</b>	<b>TS-474</b> (Set of 3)	
<b>STH-B</b>	21 x 7 12 x 7	Collar Cuffs (2)	<b>BP-72**</b> <b>BP-20**</b>	<b>B-72**</b> <b>B-20**</b>	<b>HS-72**</b> <b>HS-20**</b>	<b>HB-72</b> <b>HB-20</b>	<b>TS-475</b> (Set of 3)	
<b>STH-S</b>	19 x 7 12 x 7	Collar Cuffs (2)	<b>BP-1179</b> <b>BP-1178</b>	<b>B-1179</b> <b>B-1178</b>	<b>HS-1179</b> <b>HS-1178</b>	<b>HB-1179</b> <b>HB-1178</b>	<b>TS-476</b> (Set of 3)	
<b>STHG-A</b>	21 x 8 10 x 10	Collar Gusset Cuffs (2)	<b>BP-81</b> <b>BP-12</b>	<b>B-81</b> <b>B-12</b>	<b>HS-81</b> <b>HS-12</b>	<b>HB-81</b> <b>HB-12</b>	<b>TS-477</b> (Set of 3)	
<b>STHG-B</b>	21 x 7 10 x 10	Collar Gusset Cuffs (2)	<b>BP-72</b> <b>BP-12</b>	<b>B-72</b> <b>B-12</b>	<b>HS-72</b> <b>HS-12</b>	<b>HB-72</b> <b>HB-12</b>	<b>TS-478</b> (Set of 3)	
<b>STHS-Y</b>	22 x 9 12 x 7	Collar/Yoke Cuffs (2)	<b>BP-1339</b> <b>BP-1178</b>	<b>B-1339</b> <b>B-1178</b>	<b>HS-1339</b> <b>HS-1178</b>	<b>HB-1339</b> <b>HB-1178</b>	<b>TS-479</b> (Set of 3)	
<b>ULC</b>	49 x 8 3/4	Lapel Collar/Cuff	<b>BP-1694</b>	<b>B-1694</b>	<b>HS-1694</b>	<b>HB-1694</b>	<b>TS-1694</b>	
<b>ULP</b>	43 1/2 x 7 1/2	Lapel Press	<b>BP-1707</b>	<b>B-1707</b>	<b>HS-1707</b>	<b>HB-1707</b>	<b>TS-1707</b>	
<b>WAZ</b>	50 x 18 x 9	Tapered	<b>BP-230</b>	<b>B-230</b>	<b>HS-230</b>	<b>HB-230</b>	<b>TS-516</b>	

MFG. MODEL NUMBER	Buck Size	DESCRIPTION	RED OPEN WEAVE ARAMID COVER	50 OZ. BONN-E-BLUE	TEXSTEEL BASE PAD*
<b>WCZ</b> <b>Single Collar &amp; Cuff</b>	19 5/8 x 9 11 7/8 x 7	Collar Cuffs (2)	<b>ROWN-1185</b> <b>ROWN-1178</b>	<b>HB-1185</b> <b>HB-1178</b>	<b>TS-565 (Set of 3)</b>

\*Spring pads must be removed prior to installation of Texsteel steel Base Pads.

MFG. MODEL NUMBER	BUCK SIZE	DESCRIPTION	RED OPEN WEAVE ARAMID COVER/PAD	RED OPEN WEAVE ARAMID COVER	50 OZ. BONN-E-BLUE PAD	ARAMID SILICONE POCKET COVER***	SILICONE BASE PAD
<b>Lightning NT-1</b> <b>Collar &amp; Cuff</b>	19 5/8 x 9 13 1/4 x 9 13 1/4 x 9	Collar Left Cuff Right Cuff	<b>N/A</b> <b>URH-1976</b> <b>URH-1977</b>	<b>ROWN-1185</b> <b>N/A</b> <b>N/A</b>	<b>HB-1185</b> <b>N/A</b> <b>N/A</b>	<b>BA-2094</b> <b>BA-1982</b> <b>BA-1983</b>	<b>CS-1896</b> (Set of 3)

\*\*\* MUST BE USED WITH SILICONE PADDING.

\* SPECIFY BARE BUCK  
or OVER SPRINGS

\*\* For Skirted Tie On Covers order the following Bonnco code:

Collar                      89    Cuffs (2)                      24

# LAUNDRY



## UNIPRESS CABINET AIR BAG BODY PRESSES

MFG. MODEL NUMBER	BUCK SIZE	DESCRIPTION	COMBO	COVERS		PADS	
			BONPAK NYLON COVER/PAD	BON-SPUN NYLON	HI-SPUN ARAMID	50 OZ. BONN-E-BLUE	TEXSTEEL STEEL BASE PAD*
<b>W-1</b>	40 x 17	Body Bosom	<b>BP-205</b>	<b>B-205</b>	<b>HS-205</b>	<b>HB-205</b>	<b>TS-480</b>
<b>EF-2C</b>	21 x 11 12 x 7	Collar/Yoke Cuff (Electric)	<b>N/A</b> <b>N/A</b>	<b>N/A</b> <b>N/A</b>	<b>HS-1175</b> <b>HS-1178</b>	<b>HB-1175</b> <b>HB-1178</b>	<b>TS-452</b> (Set of 2)
<b>F-2C</b>	21 x 11 12 x 7	Collar/Yoke Cuff	<b>BP-1175</b> <b>BP-1178</b>	<b>B-1175</b> <b>B-1178</b>	<b>HS-1175</b> <b>HS-1178</b>	<b>HB-1175</b> <b>HB-1178</b>	<b>TS-452</b> (Set of 2)
<b>F-2CB</b>	17 x 7 1/2 11 x 6	Boys Collar/Yoke Cuff	<b>BP-1173</b> <b>BP-1176</b>	<b>B-1173</b> <b>B-1176</b>	<b>HS-1173</b> <b>HS-1176</b>	<b>HB-1173</b> <b>HB-1176</b>	<b>TS-445</b> (Set of 2)
<b>SS-2-A</b>	23 x 12 x 7	Two Lay Sleever	<b>CP-458</b> Polyester Cover		<b>HB-458</b> 50 Oz. Bonn-E-Blue Pad		<b>TS-481</b>
<b>SS-2-B</b>	23 x 11 x 7	Two Lay Sleever	<b>CP-458</b> Polyester Cover		<b>HB-458</b> 50 Oz. Bonn-E-Blue Pad		<b>TS-482</b>

MFG. MODEL NUMBER	BUCK SIZE	DESCRIPTION	COMBO	COVERS		PADS	
			BONPAK NYLON COVER/PAD	BON-SPUN NYLON	HI-SPUN ARAMID	50 OZ. BONN-E-BLUE	TEXSTEEL STEEL BASE PAD*
<b>3-TZ</b> Serial # prior to 0749218	19 1/2 x 8 12 x 7	Collar Cuffs (2)	<b>BP-72**</b> <b>BP-20**</b>	<b>B-72**</b> <b>B-20**</b>	<b>HS-72**</b> <b>HS-20**</b>	<b>HB-72</b> <b>HB-20</b>	<b>TS-465</b> (Set of 3)

MFG. MODEL NUMBER	BUCK SIZE	DESCRIPTION	RED OPEN WEAVE ARAMID COVER	50 OZ. BONN-E-BLUE PAD	ARAMID SILICONE POCKET COVER***	SILICONE BASE PAD
			<b>3-TZ</b> Serial # after 0749218	19 5/8 x 9 12 x 7	Collar Cuff (2)	<b>ROWN-1185</b> <b>ROWN-1178</b>

\*\*\* MUST BE USED WITH SILICONE PADDING.

MFG. MODEL NUMBER	BUCK SIZE	DESCRIPTION	COMBO	COVERS		PADS	
			BONPAK NYLON COVER/PAD	BON-SPUN NYLON	HI-SPUN ARAMID	50 OZ. BONN-E-BLUE	TEXSTEEL STEEL BASE PAD*
<b>3TZP</b>	19 5/8 x 9 12 x 11 x 7 12 x 11 x 7	Collar Pleat Cuff - Left Pleat Cuff - Right	<b>BP-1185</b> <b>BP-1193</b> <b>BP-1194</b>	<b>B-1185</b> <b>B-1193</b> <b>B-1194</b>	<b>HS-1185</b> <b>HS-1193</b> <b>HS-1194</b>	<b>HB-1185</b> <b>HB-1193</b> <b>HB-1194</b>	<b>TS-566</b> (Set of 3)

\*\* For Skirted Tie On Covers order the following Bonnco code:

Collar 89  
Cuffs (2) 24

\* SPECIFY BARE BUCK or OVER SPRINGS

# LAUNDRY



## UNIPRESS FLATBED PRESSES

MFG. MODEL NUMBER	BUCK SIZE	DESCRIPTION	COMBO	COVERS		PADS	
			BONPAK NYLON COVER/PAD	BON-SPUN NYLON	HI-SPUN ARAMID	50 OZ. BONN-E-BLUE	TEXSTEEL STEEL BASE PAD*
<b>F-3T</b> Serial # prior to 723188	19 x 7	Collar	<b>BP-1179</b>	<b>B-1179</b>	<b>HS-1179</b>	<b>HB-1179</b>	<b>TS-476</b> (Set of 3)
	12 x 7	Cuffs (2)	<b>BP-1178</b>	<b>B-1178</b>	<b>HS-1178</b>	<b>HB-1178</b>	

MFG. MODEL NUMBER	BUCK SIZE	DESCRIPTION	RED OPEN WEAVE ARAMID	50 OZ. BONN-E-BLUE PAD	30 OZ. BONN-E-BLUE PAD	TEXSTEEL STEEL*
			ROWN-1179 ROWN-1178	HB-1179 HB-1178	FB-1179 FB-1178	TS-476 (Set of 3)
<b>F-3T</b> Serial # after 723188	19 x 7	Collar	<b>ROWN-1179</b>	<b>HB-1179</b>	<b>FB-1179</b>	<b>TS-476</b> (Set of 3)
	12 x 7	Cuff (2)	<b>ROWN-1178</b>	<b>HB-1178</b>	<b>FB-1178</b>	

\* WHEN ORDERING NEW TEXSTEEL BASE PADS, USE 30 OZ. PADDING.

MFG. MODEL NUMBER	BUCK SIZE	DESCRIPTION	COMBO	COVERS		PADS	
			BONPAK NYLON COVER/PAD	BON-SPUN NYLON	HI-SPUN ARAMID	50 OZ. BONN-E-BLUE	TEXSTEEL STEEL BASE PAD*
<b>F-3TB</b>	19 x 7	Boy's Collar	<b>BP-1179</b>	<b>B-1179</b>	<b>HS-1179</b>	<b>HB-1179</b>	<b>TS-448</b> (Set of 3)
	12 x 7	Cuffs(2)	<b>BP-1176</b>	<b>B-1176</b>	<b>HS-1176</b>	<b>HB-1176</b>	
<b>F-3TC</b>	21 x 11	Collar/Yoke	<b>BP-1175</b>	<b>B-1175</b>	<b>HS-1175</b>	<b>HB-1175</b>	<b>TS-452</b> (Set of 2)
	12 x 7	Cuff	<b>BP-1178</b>	<b>B-1178</b>	<b>HS-1178</b>	<b>HB-1178</b>	
<b>F-3TP</b>	19 x 7	Collar	<b>BP-1179</b>	<b>B-1179</b>	<b>HS-1179</b>	<b>HB-1179</b>	<b>TS-568</b> (Set of 3)
	12 x 11 x 7	Pleat Cuff - Left	<b>BP-1193</b>	<b>B-1193</b>	<b>HS-1193</b>	<b>HB-1193</b>	
	12 x 11 x 7	Pleat Cuff - Right	<b>BP-1194</b>	<b>B-1194</b>	<b>HS-1194</b>	<b>HB-1194</b>	
<b>F-3TY</b>	22 x 9	Collar/Yoke	<b>BP-1339</b>	<b>B-1339</b>	<b>HS-1339</b>	<b>HB-1339</b>	<b>TS-479</b> (Set of 3)
	12 x 7	Cuffs (2)	<b>BP-1178</b>	<b>B-1178</b>	<b>HS-1178</b>	<b>HB-1178</b>	

MFG. MODEL NUMBER	BUCK SIZE	DESCRIPTION	RED OPEN WEAVE ARAMID	50 OZ. BONN-E-BLUE PAD	30 OZ. BONN-E-BLUE PAD***	TEXSTEEL BASE PAD*
			ROWN-1179 ROWN-1178	HB-1179 HB-1178	FB-1179 FB-1178	TS-476 (Set of 3)
<b>L3T</b>	19 5/8 x 9	Collar	<b>ROWN-1179</b>	<b>HB-1179</b>	<b>FB-1179</b>	<b>TS-476</b> (Set of 3)
	11 7/8 x 7	Cuff (2)	<b>ROWN-1178</b>	<b>HB-1178</b>	<b>FB-1178</b>	

\* WHEN ORDERING NEW TEXSTEEL BASE PADS, USE 30 OZ. PADDING.

MFG. MODEL NUMBER	BUCK SIZE	DESCRIPTION	COMBO	COVERS		PADS	
			BONPAK NYLON COVER/PAD	BON-SPUN NYLON	HI-SPUN ARAMID	50 OZ. BONN-E-BLUE	TEXSTEEL STEEL BASE PAD*
<b>V-3T</b>	19 x 7	Collar	<b>BP-1179</b>	<b>B-1179</b>	<b>HS-1179</b>	<b>HB-1179</b>	<b>TS-476</b> (Set of 3)
	12 x 7	Cuffs (2)	<b>BP-1178</b>	<b>B-1178</b>	<b>HS-1178</b>	<b>HB-1178</b>	
<b>V3TP</b>	19 x 7	Collar	<b>BP-1185</b>	<b>B-1185</b>	<b>HS-1185</b>	<b>HB-1185</b>	<b>TS-566</b> (Set of 3)
	12 x 11 x 7	Pleat Cuff - Left	<b>BP-1193</b>	<b>B-1193</b>	<b>HS-1193</b>	<b>HB-1193</b>	
	12 x 11 x 7	Pleat Cuff - Right	<b>BP-1194</b>	<b>B-1194</b>	<b>HS-1194</b>	<b>HB-1194</b>	
<b>VASY3</b>	19 5/8 x 9	Collar/Yoke	<b>BP-1185</b>	<b>B-1185</b>	<b>HS-1185</b>	<b>HB-1185</b>	<b>TS-565</b> (Set of 3)
	12 x 7	Cuffs (2)	<b>BP-1178</b>	<b>B-1178</b>	<b>HS-1178</b>	<b>HB-1178</b>	
<b>VASY3P</b> <b>VASY3PC</b>	19 5/8 x 9	Collar/Yoke	<b>BP-1185</b>	<b>B-1185</b>	<b>HS-1185</b>	<b>HB-1185</b>	<b>TS-566</b> (Set of 3)
	12 x 11 x 7	Pleat Cuff (Left)	<b>BP-1193</b>	<b>B-1193</b>	<b>HS-1193</b>	<b>HB-1193</b>	
	12 x 11 x 7	Pleat Cuff (Right)	<b>BP-1194</b>	<b>B-1194</b>	<b>HS-1194</b>	<b>HB-1194</b>	

\* SPECIFY BARE BUCK or OVER SPRINGS

# LAUNDRY



## UNIPRESS FLATBED PRESSES

MFG. MODEL NUMBER	BUCK SIZE	DESCRIPTION	RED OPEN WEAVE ARAMID COVER	50 OZ. BONN-E-BLUE	TEXSTEEL BASE PAD*
<b>QT4</b> Double Collar & Cuff	19 5/8 x 9 11 7/8 x 7	Collar (2) Cuffs (4)	<b>ROWN-1185</b> <b>ROWN-1178</b>	<b>HB-1185</b> <b>HB-1178</b>	<b>TS-565 (Set of 3)**</b>

\*Spring pads must be removed prior to installation of Texsteel steel Base Pads.

\*\*Requires 2 Sets

MFG. MODEL NUMBER	BUCK SIZE	DESCRIPTION	COMBO	COVERS		PADS	
			BONPAK NYLON COVER/PAD	BON-SPUN NYLON	HI-SPUN ARAMID	50 OZ. BONN-E-BLUE	TEXSTEEL STEEL BASE PAD*
<b>W-4-A</b>	53 1/2 x 18 x 14	Legger w/Cut-Out	<b>BP-253</b>	<b>B-253</b>	<b>HS-253</b>	<b>HB-253</b>	<b>TS-483</b>
<b>W-4-B</b>	53 1/2 x 18 x 7	Legger	<b>BP-252</b>	<b>B-252</b>	<b>HS-252</b>	<b>HB-252</b>	<b>TS-484</b>
<b>YC-17-A</b>	17 x 10 1/2	Yoke w/Cut-Out	<b>BP-34</b>	<b>B-34</b>	<b>HS-34</b>	<b>HB-34</b>	<b>TS-486</b>
<b>19-SY</b>	19 x 11	Yoke	<b>BP-60</b>	<b>B-60</b>	<b>HS-60</b>	<b>HB-60</b>	<b>TS-487</b>
<b>YC-19-A</b>	19 x 11 x 6	Yoke w/Cut-Out	<b>BP-52</b>	<b>B-52</b>	<b>HS-52</b>	<b>HB-52</b>	<b>TS-492</b>
<b>YC-19-B</b>	19 x 11 x 5	Yoke w/Cut-Out	<b>BP-52</b>	<b>B-52</b>	<b>HS-52</b>	<b>HB-52</b>	<b>TS-493</b>
<b>YC-20-A</b>	20 x 10 x 6	Yoke w/Cut-Out	<b>BP-85</b>	<b>B-85</b>	<b>HS-85</b>	<b>HB-85</b>	<b>TS-494</b>
<b>C-21-A</b>	21 x 11 1/2	Rectangular	<b>BP-86</b>	<b>B-86</b>	<b>HS-86</b>	<b>HB-86</b>	<b>TS-495</b>
<b>SC-21-E</b>	19 x 7	Collar (Electric)	<b>N/A</b>	<b>N/A</b>	<b>HS-1179</b>	<b>HB-1179</b>	<b>TS-496</b>
<b>YC-21-B</b>	20 x 10 x 6	Yoke w/Cut-Out	<b>BP-85</b>	<b>B-85</b>	<b>HS-85</b>	<b>HB-85</b>	<b>TS-497</b>
<b>SYC-22</b>	22 x 10	Yoke w/Cut-Out	<b>BP-119</b>	<b>B-119</b>	<b>HS-119</b>	<b>HB-119</b>	<b>TS-498</b>
<b>BY-23-B</b>	22 1/2 x 13	Yoke	<b>BP-127</b>	<b>B-127</b>	<b>HS-127</b>	<b>HB-127</b>	<b>TS-499</b>
<b>YC-23-A</b>	23 x 11 x 6	Yoke w/Cut-Out	<b>BP-119</b>	<b>B-119</b>	<b>HS-119</b>	<b>HB-119</b>	<b>TS-501</b>
<b>CL-26-B</b>	23 1/2 x 12 1/2	Collar/Lapel	<b>BP-152</b>	<b>B-152</b>	<b>HS-152</b>	<b>HB-152</b>	<b>TS-502</b>
<b>32-S</b>	30 x 13 x 10	Body Bosom	<b>BP-166</b>	<b>B-166</b>	<b>HS-166</b>	<b>HB-166</b>	<b>TS-503</b>
<b>32-SW</b>	30 x 14 x 10	Body Bosom	<b>BP-1681</b>	<b>B-1681</b>	<b>HS-1681</b>	<b>HB-1681</b>	<b>TS-560</b>
<b>E-32-S</b>	30 x 13 x 10	Body Bosom (Electric)	<b>N/A</b>	<b>N/A</b>	<b>HS-166</b>	<b>HB-166</b>	<b>TS-504</b>
<b>E-32-SW</b>	30 x 14 x 10	Body Bosom (Electric)	<b>N/A</b>	<b>N/A</b>	<b>HS-1681</b>	<b>HB-1681</b>	<b>TS-561</b>
<b>CV-33-B</b>	32 1/2 x 15 x 12 1/2	Coverall	<b>BP-173</b>	<b>B-173</b>	<b>HS-173</b>	<b>HB-173</b>	<b>TS-506</b>
<b>CV-33-E</b>	32 1/2 x 15 x 12 1/2	Coverall (Electric)	<b>N/A</b>	<b>N/A</b>	<b>HS-173</b>	<b>HB-173</b>	<b>TS-507</b>
<b>37</b>	35 x 20	Body Bosom	<b>BP-185</b>	<b>B-185</b>	<b>HS-185</b>	<b>HB-185</b>	<b>TS-508</b>

\* SPECIFY BARE BUCK or OVER SPRINGS

**LA 86**

CALL OR EMAIL US WITH ANY QUESTIONS  
937-462-5148 CUSTOMERSERVICE@FHBONN.COM

# LAUNDRY



## UNIPRESS FLATBED PRESSES

MFG. MODEL NUMBER	BUCK SIZE	DESCRIPTION	COMBO	COVERS		PADS	TEXSTEEL STEEL BASE PAD*
			BONPAK NYLON COVER/ PAD	BON-SPUN NYLON	HI-SPUN ARAMID	50 OZ. BONN-E- BLUE	
<b>C-38-A</b>	38 x 12 x 8	Tapered	<b>BP-200</b>	<b>B-200</b>	<b>HS-200</b>	<b>HB-200</b>	<b>TS- 509</b>
<b>39-S</b>	38 x 18	Body Bosom	<b>BP-198</b>	<b>B-198</b>	<b>HS-198</b>	<b>HB-198</b>	<b>TS- 511</b>
<b>C-40</b>	40 x 17	Body Bosom	<b>BP-208</b>	<b>B-208</b>	<b>HS-208</b>	<b>HB-208</b>	<b>TS- 512</b>
<b>SC-41-A</b>	21 x 7	Collar	<b>BP-72</b>	<b>B-72</b>	<b>HS-72</b>	<b>HB-72</b>	<b>TS- 513</b>
<b>C-42-A</b>	42 x 24 <sup>1</sup> / <sub>2</sub>	Rectangular	<b>BP-213</b>	<b>B-213</b>	<b>HS-213</b>	<b>HB-213</b>	<b>TS- 514</b>
<b>50-T-A</b>	50 x 15 x 8 <sup>1</sup> / <sub>2</sub>	Tapered	<b>BP-233</b>	<b>B-233</b>	<b>HS-233</b>	<b>HB-233</b>	<b>TS- 515</b>
<b>C-51-A</b>	50 x 18 x 9	Tapered	<b>BP-230</b>	<b>B-230</b>	<b>HS-230</b>	<b>HB-230</b>	<b>TS- 516</b>
<b>E 53-T</b>	53 <sup>3</sup> / <sub>4</sub> x 18 <sup>1</sup> / <sub>2</sub> x 13	Tapered (Electric)	<b>N/A</b>	<b>N/A</b>	<b>HS-258</b>	<b>HB-258</b>	<b>TS-579</b>
<b>53-T</b>	53 <sup>3</sup> / <sub>4</sub> x 18 <sup>1</sup> / <sub>2</sub> x 13	Tapered	<b>BP-258</b>	<b>B-258</b>	<b>HS-258</b>	<b>HB-258</b>	<b>TS- 519</b>
<b>53-TSA</b>	53 <sup>1</sup> / <sub>2</sub> x 19 x 11	Tapered	<b>BP-258</b>	<b>B-258</b>	<b>HS-258</b>	<b>HB-258</b>	<b>TS- 517</b>
<b>53-T-13-A</b>	53 <sup>3</sup> / <sub>4</sub> x 18 <sup>1</sup> / <sub>2</sub> x 13 <sup>1</sup> / <sub>2</sub>	Tapered	<b>BP-266</b>	<b>B-266</b>	<b>HS-266</b>	<b>HB-266</b>	<b>TS- 519</b>
<b>C-54-A</b>	53 x 17	Rectangular	<b>BP-254</b>	<b>B-254</b>	<b>HS-254</b>	<b>HB-254</b>	<b>TS- 550</b>
<b>C-54-B</b>	54 x 18	Rectangular	<b>BP-254</b>	<b>B-254</b>	<b>HS-254</b>	<b>HB-254</b>	<b>TS- 522</b>
<b>917-A</b>	17 x 9	Oval Mushroom	<b>BP-44</b>	<b>B-44</b>	<b>HS-44</b>	<b>HB-44</b>	<b>TS- 523</b>
<b>M-921</b>	21 x 9 <sup>1</sup> / <sub>2</sub>	Oval Mushroom	<b>BP-67</b>	<b>B-67</b>	<b>HS-67</b>	<b>HB-67</b>	<b>TS- 524</b>
<b>1019-A</b>	19 x 10 x 5 <sup>1</sup> / <sub>2</sub>	Oval Mushroom (Straight Sides)	<b>BP-51</b>	<b>B-51</b>	<b>HS-51</b>	<b>HB-51</b>	<b>TS- 525</b>
<b>EC-1019</b>	19 x 10 x 5 <sup>1</sup> / <sub>2</sub>	Oval Mushroom (Straight Sides) (Electric)	<b>N/A</b>	<b>N/A</b>	<b>HS-51</b>	<b>HB-51</b>	<b>TS- 605</b>
<b>1021-A</b>	20 x 10	Oval Mushroom	<b>BP-67</b>	<b>B-67</b>	<b>HS-67</b>	<b>HB-67</b>	<b>TS- 526</b>
<b>1219-P-A</b>	19 x 12	Oval Mushroom	<b>BP-84</b>	<b>B-84</b>	<b>HS-84</b>	<b>HB-84</b>	<b>TS- 527</b>
<b>1221-A</b>	21 x 12	Oval Mushroom	<b>BP-102</b>	<b>B-102</b>	<b>HS-102</b>	<b>HB-102</b>	<b>TS- 528</b>
<b>1222-A</b>	22 x 12	Rectangular Tapered	<b>BP-101</b>	<b>B-101</b>	<b>HS-101</b>	<b>HB-101</b>	<b>TS- 529</b>
<b>1222-RA</b>	22 x 12	Rectangular Tapered	<b>BP-103</b>	<b>B-103</b>	<b>HS-103</b>	<b>HB-103</b>	<b>TS- 530</b>

\* SPECIFY BARE BUCK  
or OVER SPRINGS

# LAUNDRY



## UNIPRESS CABINET AIR BAG BODY PRESSES

MFG. MODEL NUMBER	BUCK SIZE	DESCRIPTION	COMBO	COVERS		PADS	
			BONPAK NYLON COVER/ PAD	BON-SPUN NYLON	HI-SPUN ARAMID	50 OZ. BONN-E- BLUE	TEXSTEEL STEEL BASE PAD*
<b>1236-A</b>	36 x 1	Double End Pants Topper	<b>BP-184</b>	<b>B-184</b>	<b>HS-184</b>	<b>HB-184</b>	<b>TS-531</b>
<b>1422-A</b>	22 x 14 x 9 1/2	Rectangular Tapered	<b>BP-118</b>	<b>B-118</b>	<b>HS-118</b>	<b>HB-118</b>	<b>TS-532</b>
<b>1436-A</b>	36 x 14	Double End Pants Topper	<b>BP-187</b>	<b>B-187</b>	<b>HS-187</b>	<b>HB-187</b>	<b>TS-551</b>
<b>C-4227</b>	42 x 27	Pillow Case	<b>BP-215</b>	<b>B-215</b>	<b>HS-215</b>	<b>HB-215</b>	<b>TS-534</b>
<b>C-4524-A</b>	45 x 24	Rectangular	<b>BP-223</b>	<b>B-223</b>	<b>HS-223</b>	<b>HB-223</b>	<b>TS-538</b>
<b>C-5420-A</b>	54 x 20	Rectangular	<b>BP-260</b>	<b>B-260</b>	<b>HS-260</b>	<b>HB-260</b>	<b>TS-539</b>
<b>C-5420-LCS</b>	54 x 20	Rectangular	<b>BP-260</b>	<b>B-260</b>	<b>HS-260</b>	<b>HB-260</b>	<b>TS-541</b>
<b>C-5424-A</b>	54 x 24	Rectangular	<b>BP-263</b>	<b>B-263</b>	<b>HS-263</b>	<b>HB-263</b>	<b>TS-542</b>
<b>C-5424-B2A</b>	54 x 24	Rectangular	<b>BP-263</b>	<b>B-263</b>	<b>HS-263</b>	<b>HB-263</b>	<b>TS-543</b>
<b>5424-B2C</b>	54 x 24	Rectangular	<b>BP-243</b>	<b>B-243</b>	<b>HS-243</b>	<b>HB-243</b>	<b>TS-544</b>
<b>U-5424-B</b>	53 x 25 x 18 x 10	Uniform	<b>BP-256</b>	<b>B-256</b>	<b>HS-256</b>	<b>HB-256</b>	<b>TS-545</b>
<b>C-6420-A</b>	64 x 20	Rectangular	<b>BP-295</b>	<b>B-295</b>	<b>HS-295</b>	<b>HB-295</b>	<b>TS-546</b>
<b>FW-29110</b>	110 x 29	Flatwork Rectangular	<b>BP-427</b>	<b>B-427</b>	<b>HS-427</b>	<b>HB-427</b>	<b>TS-547</b>

\* SPECIFY BARE BUCK  
or OVER SPRINGS

## VEIT SINGLE BUCK SHIRT UNIT

MFG. MODEL NUMBER	WHITE ARAMID COVER/PAD	30 OZ. BUCK PAD	SILICONE BASE pad
<b>8900</b>	<b>WA-2670</b>	<b>FB-2670</b>	<b>RS-2670</b>

## VEIT FLATBED PRESSES

MFG. MODEL NUMBER	BUCK SIZE	DESCRIPTION	WHITE ARAMID COVER/PAD	SILICONE BASE
<b>8140</b>	25 1/2 x 7 1/2 15 x 7 1/2	Collar Cuff (2)	<b>WADB-2204</b> <b>WADB-2207</b>	<b>CS-2204</b> <b>(Set of 3)</b>

**LA 88**

CALL OR EMAIL US WITH ANY QUESTIONS  
937-462-5148 CUSTOMERSERVICE@FHBONN.COM

# LAUNDRY



## WESTERN AUTOMATION VIBRA STEAMER

LENGTH OF BAG*	BON-TWILL
<b>Standard 72" Air Chamber Bag</b>	<b>L-997</b>
<b>68 1/4" Air Chamber Bag</b>	<b>L-998</b>
<b>67" Air Chamber Bag</b>	<b>L-996</b>
<b>65 1/2" Air Chamber Bag</b>	<b>L-999</b>
<b>63" Air Chamber Bag</b>	<b>L-1106</b>

\* LENGTH OF BAG REQUIRED